



21-22 July 2011

Kuala Lumpur Convention Centre (KLCC), Malaysia

IMPLEMENTATION OF ELECTRICAL AND ENERGY ISOLATION - PETRONAS EXPERIENCE

Presented By

IR MOHD A'AZMI ISMAIL

*Resident Electrical Engineer, Petronas Gas
Bhd*

Organized by:



Content

- Introduction
- Lessons Learnt
- Type of Energy Sources
- Energy Isolation Concept
- Energy Isolation Procedure
- Energy Isolation Simulation
- Special Cases
- Management of Keys
- Ownership
- Competency and Training



Introduction



Origin : Energy Isolation Standard PTS 60.2117

This standard covers safe work practices and procedures to safeguard **employees, environment and equipment** in a place of work from the hazards of energy sources including accidental release of hazardous materials during construction, operation and maintenance activities.

Energy Isolation Standard PTS 60.2117

- 1.0 INTRODUCTION**
- 2.0 SCOPE**
- 3.0 DEFINITIONS**
- 4.0 REFERENCES**
- 5.0 STATUTORY REQUIREMENTS**
- 6.0 ENERGY ISOLATION PROCEDURE**
 - 6.1 Roles & Responsibilities**
 - 6.2 Equipment Preparation**
 - 6.3 Isolation Methods**
 - 6.3.1 Positive Isolation**
 - 6.3.2 Double Block and Bleed (DBB)**
 - 6.3.3 Single Valve Isolation (SVI)**

Energy Isolation Standard PTS 60.2117

- 
- NATIONAL
CONFERENCE ON
**ELECTRICAL
SAFETY
2011**
21-22 July 2011, KLCC
- 6.4 The Group LOTO System**
 - 6.4.1 Applying The Lockout Tagout Devices For The Group LOTO System**
 - 6.4.2 Removing The Lockout Tagout Devices For The Group LOTO System**
 - 6.4.3 Test Run / Troubleshooting of Equipment**
 - 6.5 Short Duration Instrument Isolation**
 - 6.6 Isolation and Lockout Tagout of Ionizing Radiation Sources**
 - 6.7 Isolation and Lockout Tagout During Plant Shutdown Periods**
 - 6.8 Training and Competencies**
 - 6.9 Special Safety Concerns**
 - 6.10 Documentation Communication & Approval**
 - 6.11 Management of Safety Infringement**
 - 6.12 Auditing and System Review**

Energy Isolation Standard PTS 60.2117



7.0 APPENDICES

7.1 Physical Isolation Certificate Front Side

7.2 Physical Isolation Certificate Reverse Side

7.3 Isolation / Lockout Device List Example Page 1

7.4 Isolation / Lockout Device List Example Page 2

7.5 Blank Isolation / Lockout Device List Example

7.6 Spade/Blind List Alternative Example

Energy Isolation Standard PTS 60.2117



7.7 Tags

7.8 Isolation Methods

7.9 Lockout Box Examples

7.10 Group LOTO Flowchart

7.11 Equipment Testing Flowchart

Lesson Learnt # 1: Electrical Flash Over

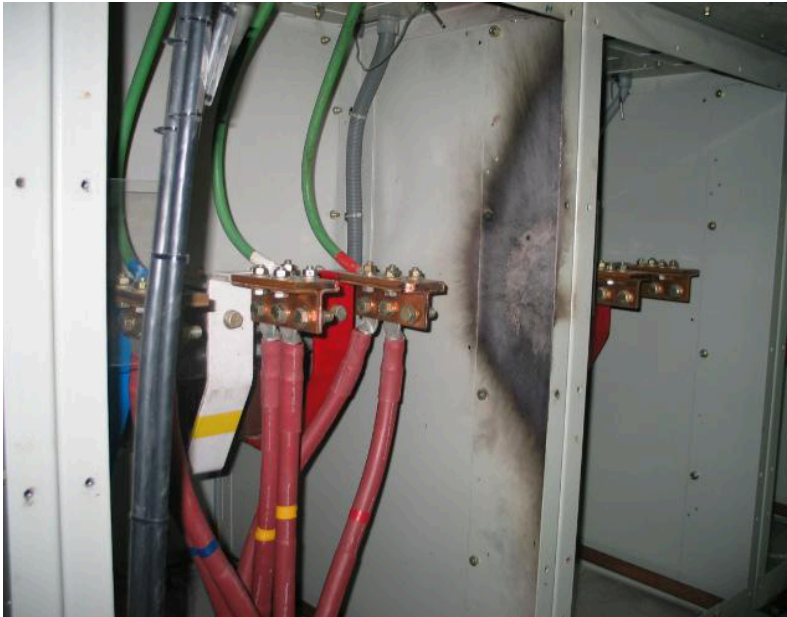
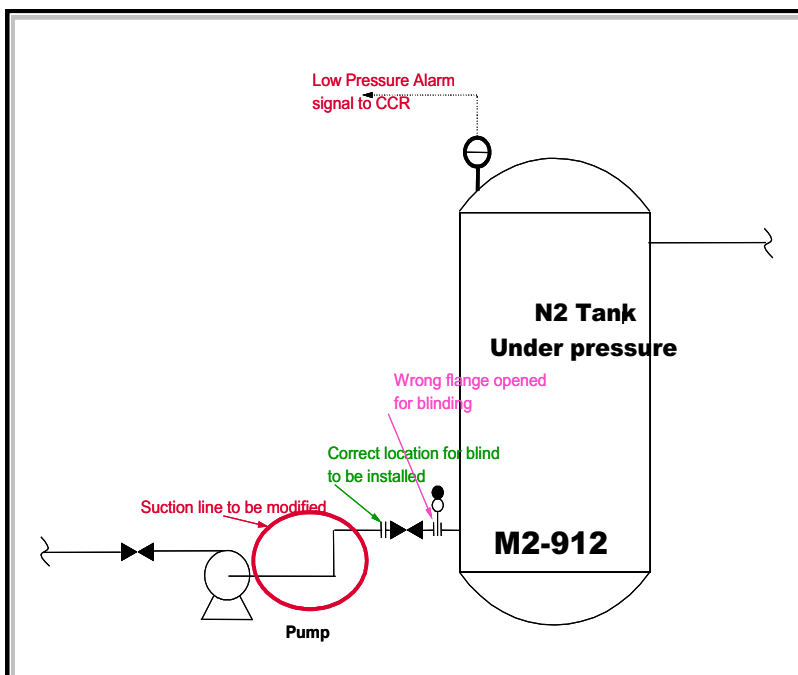

Figure 1: Flash-over occurred when earth bonding clamps was applied to 11KV cable connection bar that was still energized.

Lesson Learnt # 2: Wrong blind installation



Correct Flange

Blind Rolled by Mistake

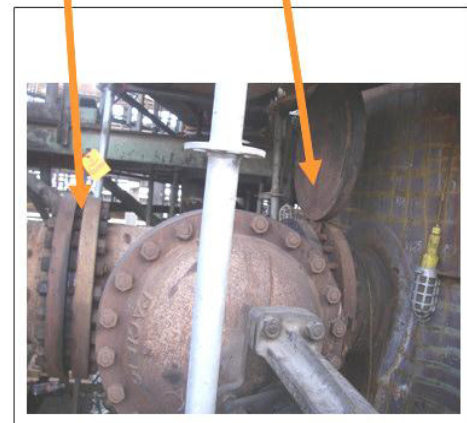

Lesson Learnt # 3: LOTO at Wrong Breaker

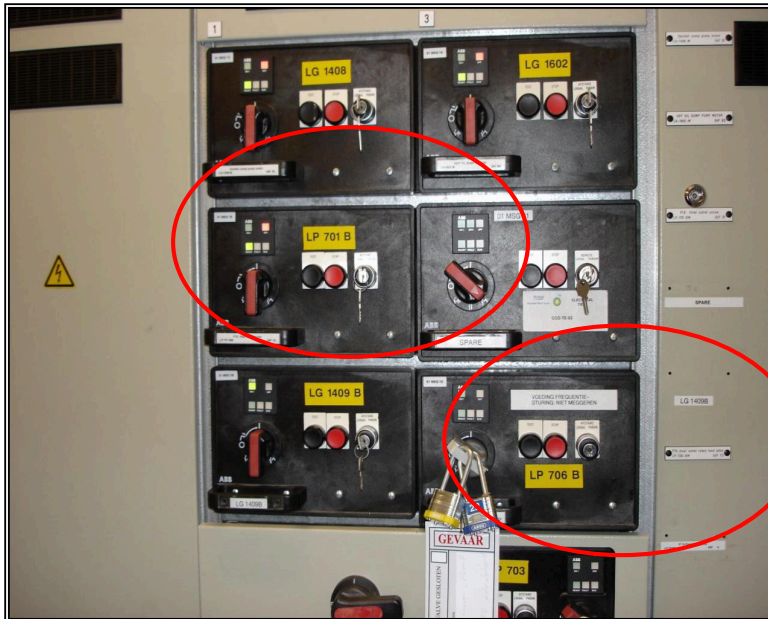

Lockout tagout done at the wrong breaker, LP 706B instead of LP 701B

Lesson Learnt # 4 : Radiation Exposure



Broken male connector
(connecting radioactive source capsule
with winding cable)

Guide Tube

Figure 1: Gamma projector with source driving and retrieval mechanism

Type of Energy Source



Type of Energy

Electrical – transmissions lines, transformers, circuit breakers, motors, lighting, impressed current of cathodic protection

Hydraulic – liquid under pressure e.g. pumps, hydro testing, hydraulic system

Pneumatic – air/gas systems under pressure, e.g. plant air, hydrocarbon gas, gas cylinder

Chemical – flammable, toxic, corrosive, reactive e.g. acid & caustic (corrosive), hydrocarbons (flammable), H₂S (toxic), hydrogen peroxide & pyrophoric material (reactive)

Kinetic – moving objects e.g. fan blades, fan belts, agitators, flywheels

Stored or potential – springs, counter weights, raised loads

Radiation – ionizing source e.g. radiography activities

Thermal – extreme temperature e.g. hot surface, cryogenic materials, steam



Energy : Consequence Of Energy Release

Electrical	:	electrocution, burn
Chemical	:	chemical burn, cold burn
Pneumatic	:	high impact injury, cut
Mechanical	:	cut, flying object
Radiation	:	burn, cell mutation
Hydraulic	:	injury, cut
Thermal	:	burn

Release of energy could result in personal injury or damage to property and environment.

Energy : Key Principle

All energy sources shall be isolated and brought down to *zero energy state* before work begins.

Special cases for consideration:

- electrical capacitor, energy stored shall be discharged
- stored energy in spring
- trapped energy in system, e.g. multiple valves isolation, clogged line



Energy Isolation Concept :



ISOLATION



LOTO



Isolation : The act of separating something (Oxford)

Type of Isolation

- Physical Isolation
- Electrical Isolation



Physical Isolation :

1. Positive Isolation

- **Spool / valve removal**
- **Blind / spade isolation** – (Blind Type : Rated, Correct Material & Correct Size)

If blind/spade cannot be applied, risk assessment is required
e.g. shutdown, space constraint, valve passing



2. Double Block and Bleed (DBB)

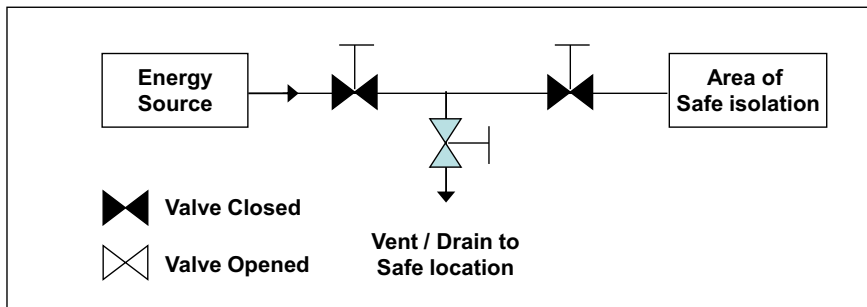

3. Single Valve Isolation (SVI)

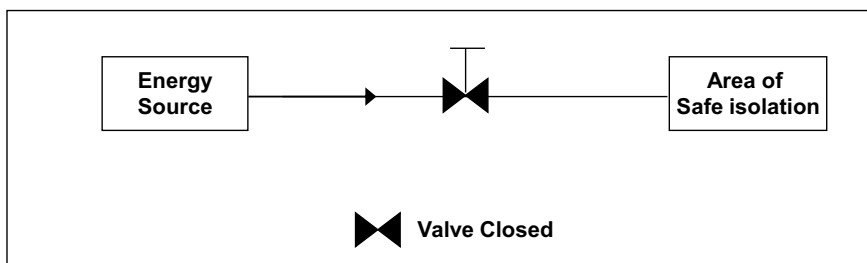

- ◆ **Positive isolation is regarded as the most secure method and must always be considered first when planning modification/maintenance work.**
- ◆ **Isolation is to be as close as possible to the inlet and outlet of the equipment to be isolated.**

Physical Isolation : Situations Requiring for Positive Isolation

- For **confined space entry**.
- For **hot or cold work** on a unit which is part of a system **containing energy source**, e.g.:
 - ◆ high temperature (touch: 60 deg C, heat stress: 38 deg C)
 - ◆ high pressure (pneumatic or hydraulic)
 - ◆ asphyxiant
 - ◆ toxic
 - ◆ corrosive
 - ◆ radioactive
- ◆ When positive isolation is not feasible, use of double block and bleed isolation may be used after a specific procedure has been developed and approved.
- For **hot or cold work** on a unit which is part of a system **containing combustible or explosive material**.

Electrical Isolation :

1. Local Push Button Isolation



2. MCC Isolation

- **Switch Off**
- **Rack Out**



LOTO : Lock Out Tag Out

Lockout (LO)

The placement of a locking device on an energy isolating device, e.g. lock & chain on an isolation valve, electrical breaker locked & open position, etc.

Tag out (TO)

The placement of a tag on an energy isolating or lock out device, e.g. on the lock, at the blind or valve, lock at the lockout box, etc.

Lock Tag Clear & Try:

After all switches, valves, and devices are locked out and tagged, and the equipment is cleared of personnel, attempts are then made to try starting the equipment (push button, actuators, etc.).



21-22 July 2011, KLCC



LOTO : Group LOTO System



21-22 July 2011, KLCC

With the Group LOTO System a series of locks with a single common master key* with tags are used to isolate the system after which the key is placed in a secured Lockout Box.

**Spare keys shall be available but must be under strict control by the Area Manager or equivalent.*

Different color coded tags being used:

Blue (plastic) – Operations

Red (plastic) – Electrical

Yellow (plastic) – Ionizing Radiation

Brown (paper) – Common disposable tag used at lockout box

Green (paper) – Spade/blind

LOTO :Tags



Operations Permanent type plastic tag



Chargeman Permanent type plastic tag



RPO/RPS Permanent type plastic tag



Disposable Tag for use with locks on Lockout Box (Paper/Tyvec or similar material)



Disposable Tag with serial number, duplicated on perforated section. Used to identify Spade/Blind location (Paper/Tyvec or similar material)

LOTO : Tags For Physical Isolation

Operation tag at valve (Blue) & blind (Green)



LOTO : Tags For Electrical Isolation

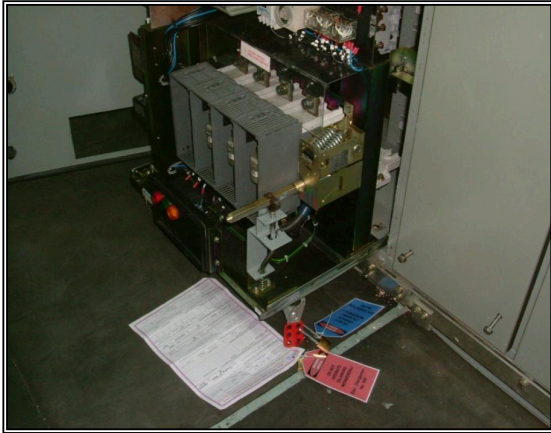

Electrical ACP lock & tag (red) and Operation group lock & tag (blue)

Operation group lock & tag (blue)



LOTO : Tags For Lockout Box

Lockout Box

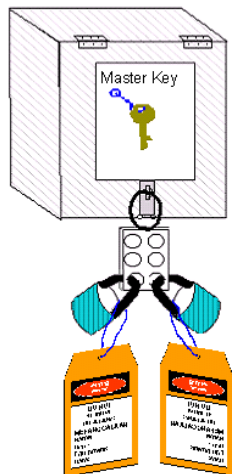

El : Roles and Responsibilities



Approving Authority (AA):

- approving PTW for modification and/or maintenance work on equipment or systems where energy isolation is required.
- assessing the hazard associated with the work and recommend control measures.
- ensure that the Job Method Statement (JMS) and/or JSA/JHA is available.
- ensure only trained and competent personnel perform the preparation and isolation activities.

Approving Authority Representative (AAR):

- Appointed by the Approving Authority to prepare and isolate the equipment.
- May also be instructed to install any lockout devices and tags under the supervision of the Approving Authority.
- Shall be competent to operate the equipment and understand the process / system being isolated.

El : Roles and Responsibilities



Receiving Authority (RA):

- Responsible for supervising the maintenance activities
- Ensures that the system or equipment being worked on has been safely isolated and disabled with proper lockout and tags.
- Accepts the PTW issued for work to be carried out under his supervision.

Receiving Authority Representative (RAR):

- Responsible for carrying out maintenance works
- Checks and confirms that the system or equipment being worked on has been safely isolated and disabled with proper lockout and tags.

El : Group LOTO Flowchart



GROUP LOTO FLOWCHART

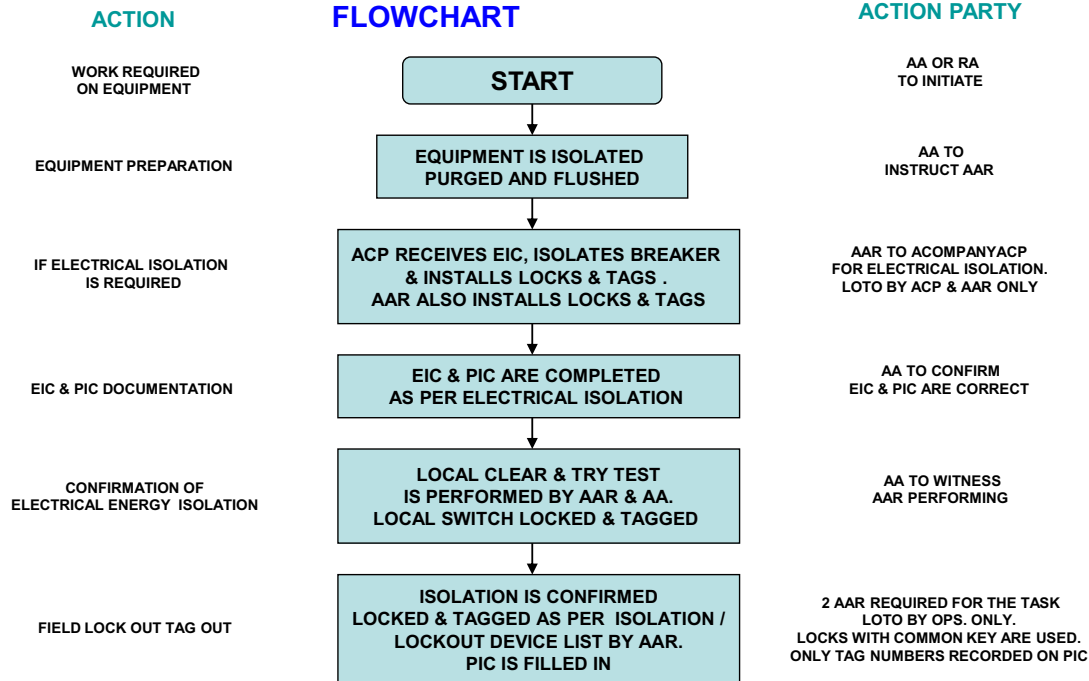

El : Group LOTO Flowchart (Cont...)

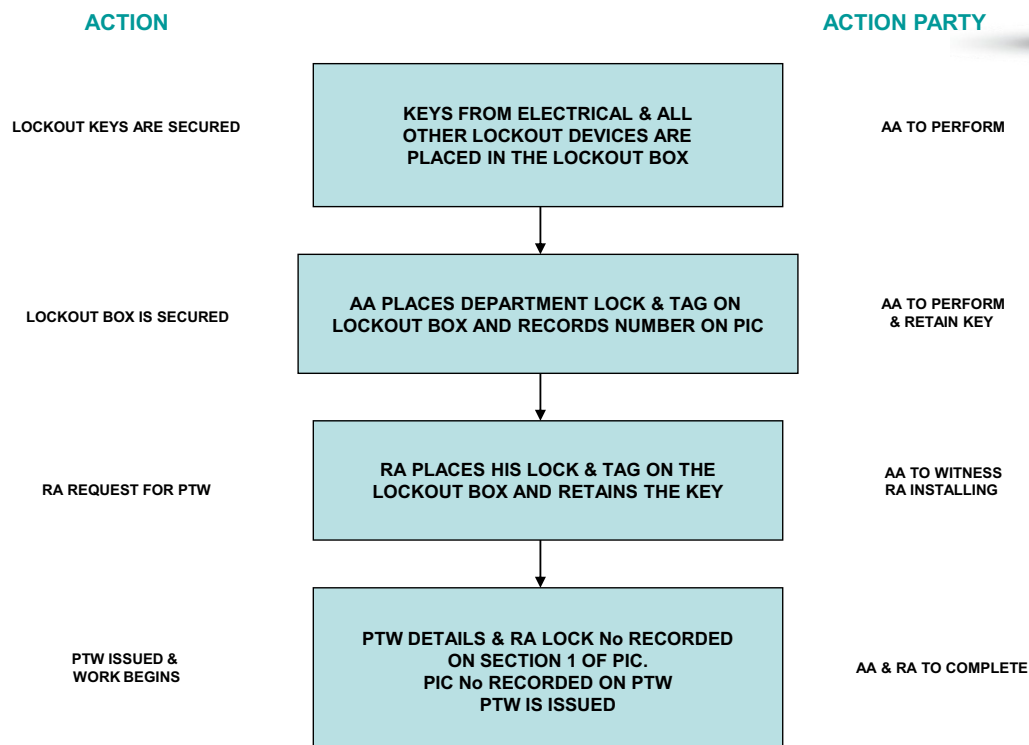

EI : Group LOTO Flowchart (Cont...)

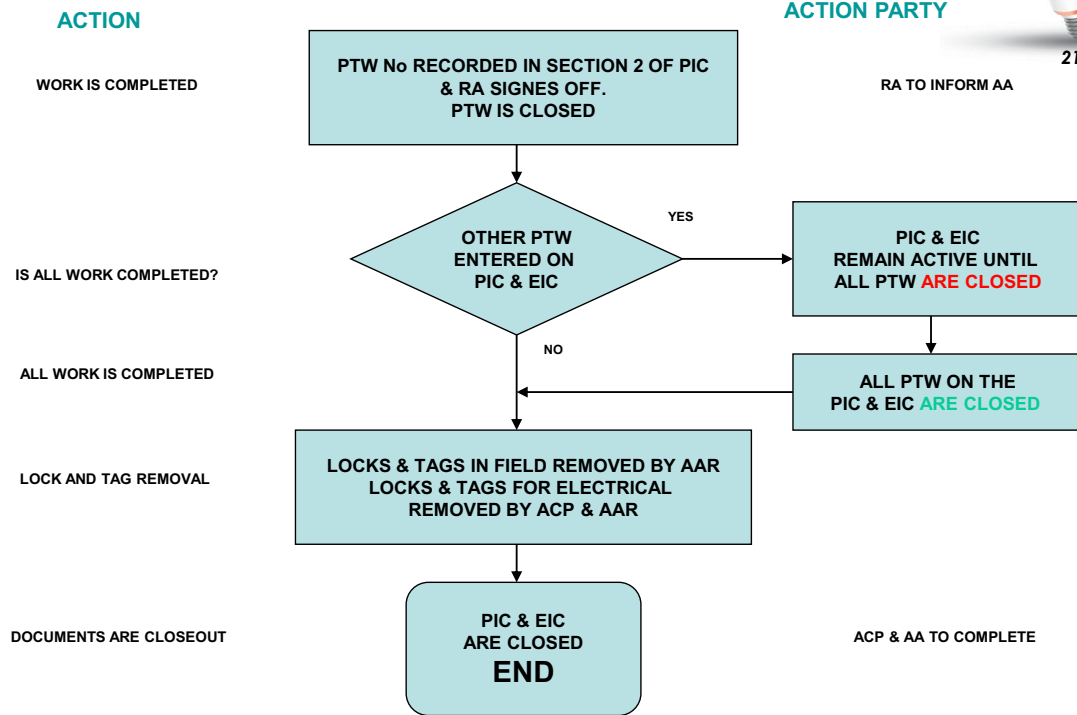

Energy Isolation Simulation



- Identify the energy source

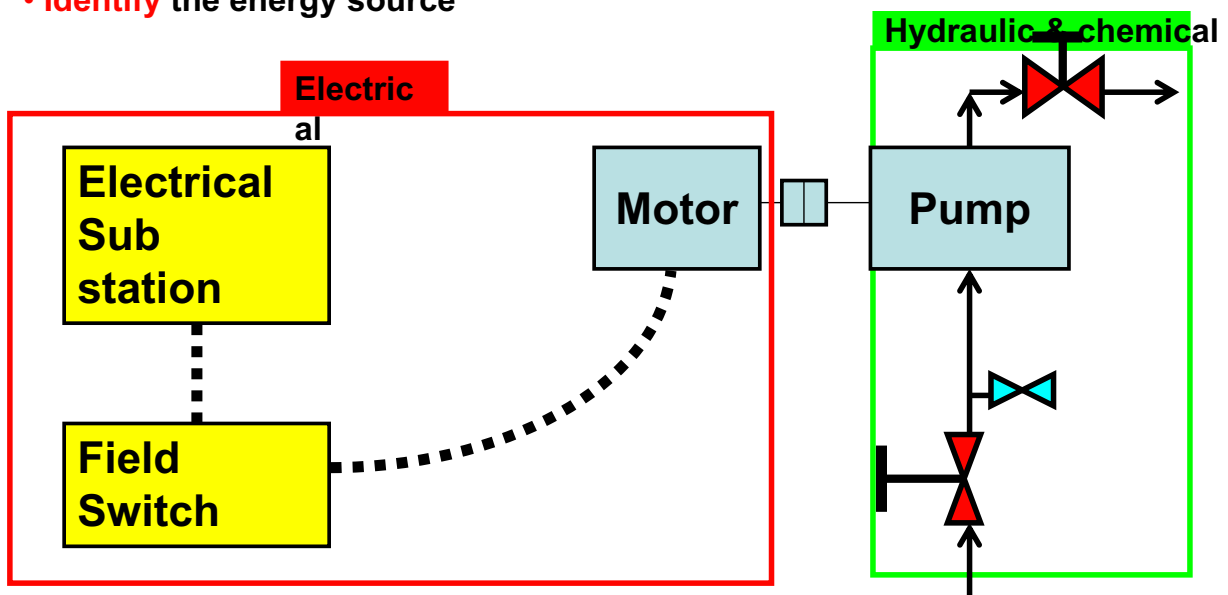

- **Isolate** the energy at substation & local switch and apply locking & tagging (LOTO)

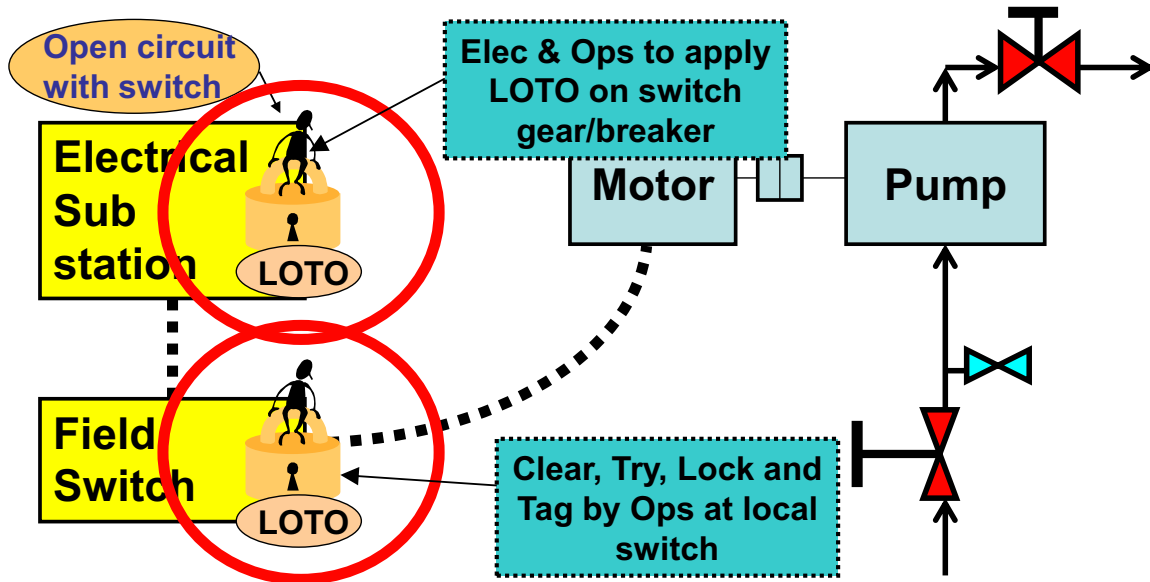

- **Verify** whether it is safe to work on (zero energy state)
 Hydraulic - valve isolation and **depressurize**

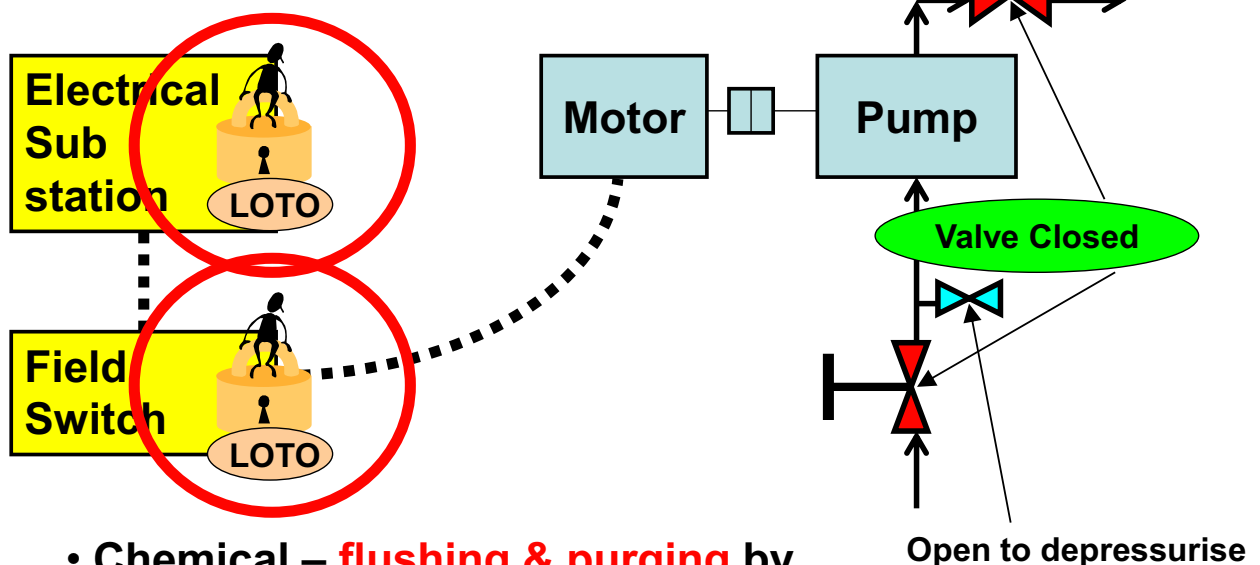

- **Chemical – flushing & purging** by steam / nitrogen / condensate / water

• Locking & tagging (LOTO) at the valve

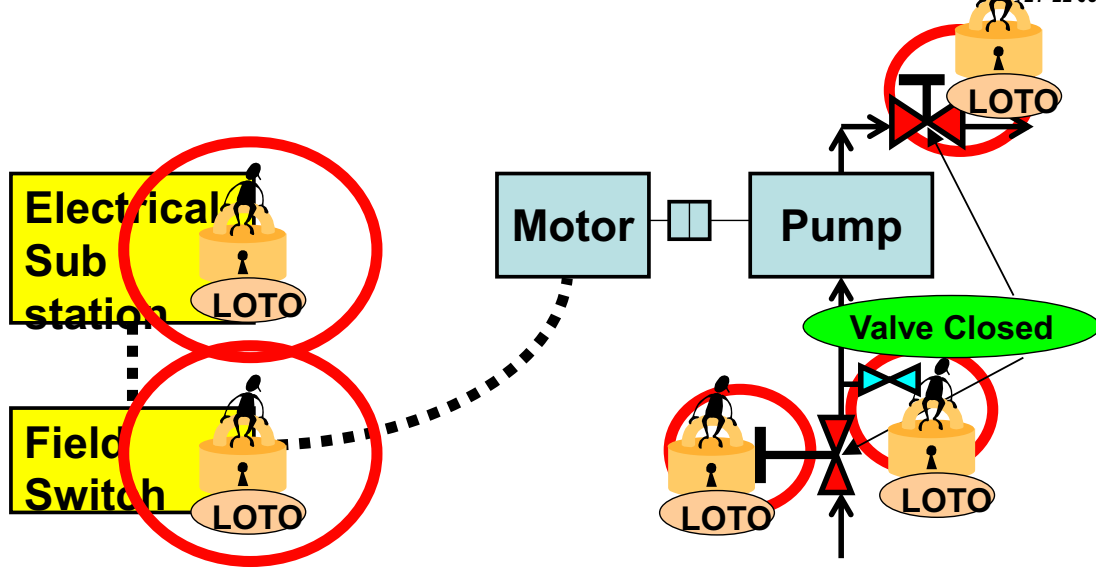

• Spading at confirmed location of valve flange

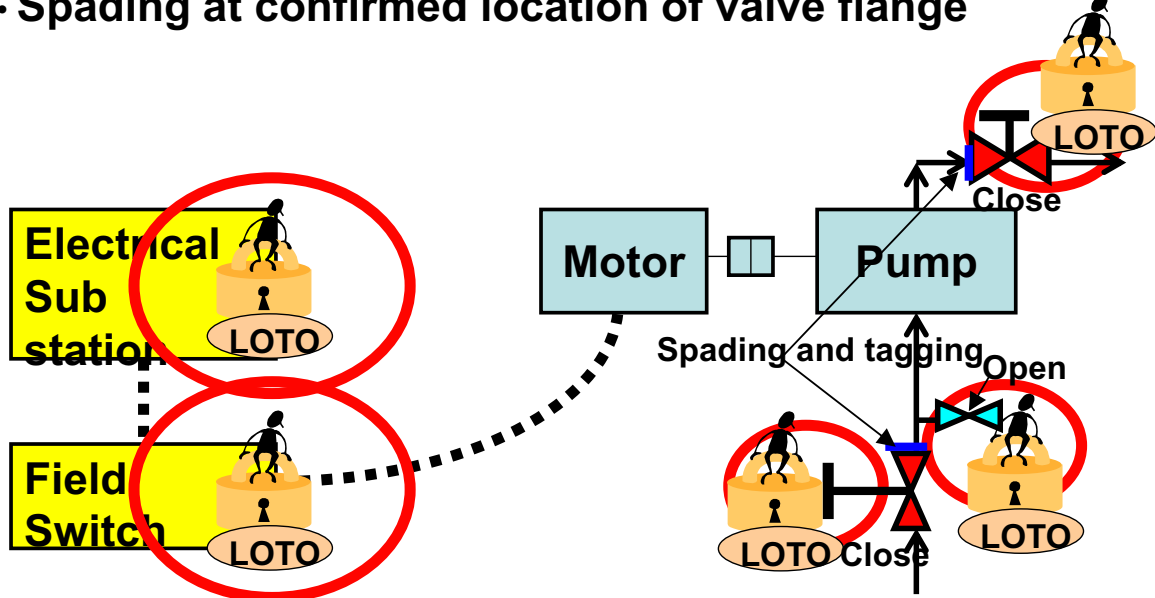

• Ready for maintenance work

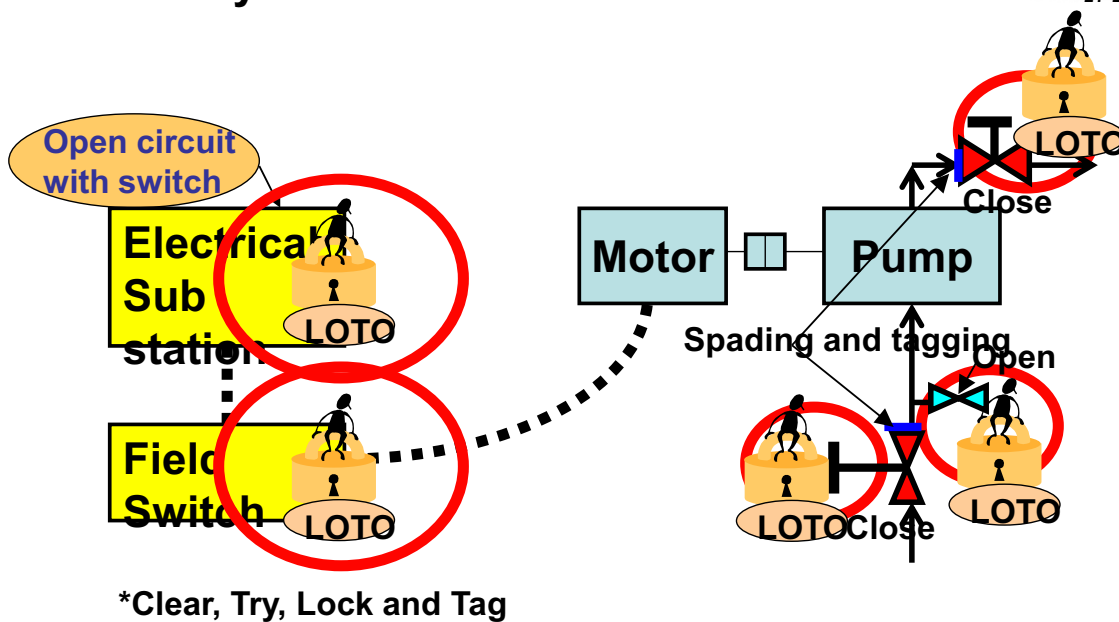

El :Special Case (1/3)

1. Isolation and LOTO during plant shutdown periods (Applicable for standalone facilities only – after the area being declassified i.e. hydrocarbon free)
 - LOTO applies at battery limits isolation.
 - LOTO also applies for Electrical and ionizing radiation sources.
 - Tags only with the PIC (no lockout devices) will be used for other process isolation.
 - The PIC, EIC and RC (Radiation Certificate) shall be used as in normal circumstances.
 - Positive isolation (i.e. blinds/spades, spool removal, valve removal etc.) requirements shall be applied for all confined space entry activities.

El :Special Case (2/3)

2. Short Duration Instrument Isolation

- Short duration tasks, e.g. routine calibration of instruments, may be done with single valve isolations, and an instrument technician may effect the isolation.
- A Permit to Work (PTW) is required and this must state that the 'Equipment has been Isolated without PIC'.
- If the job is strictly supervised, the lockout or tagout device on the isolation valve(s) is not required.

El :Special Case (2/3) cont

However, single valve isolations effected by instrument technicians are **NOT** allowed under the following process conditions:

Process fluid	Pressure*	Temperature*
Flammable - Flash point below ambient temp.	>55Barg	>200°C
Toxic - subject to USECHH regulations	-	-
Line Breaking – containing hazardous material	-	-
Line Breaking – containing non-hazardous material	>30Barg	>50°C

*either/or If the period of isolation is to be extended, or if the isolated instrument is to be removed, then full isolation must be implemented by a process technician. Under these circumstances the isolation valve(s) must be locked and tagged.

El :Special Case (3/3)



3. Test run and troubleshooting

This is allowed under the following conditions:

RA requesting the test run informs the AA

- AA withdraws all PTW listed on the PIC and the RAs remove the department lock & tag from the lockout box.
- AA removes his department lock & tag from the lockout box and makes the Group Lock keys available for de-isolation. Only equipment related to the test is de-isolated.
- RA proceeds with the equipment test.
- Once the test is completed, RA informs the AA.
- AA will then ensure the equipment isolation returns to previous condition and secures the Group Lock keys in the lockout box.
- PTW may be revalidated after RA places the department lock and tag on the lockout box.

El : Management of Keys



▪ Field / substation

- Operations key (Group lock with master key)
- Electrical key (department lock with individual key)
- RPO key (department lock with individual key)

▪ Lockout Box station

- AA key (department lock with individual key)
- RA key (department lock with individual key)

EI :Ownership

- **Handover between shifts or change of AA / RA**
 - keys shall be handed over personally and recorded in the key handover log book by each department
 - handover of PTW, PIC, EIC and other certificates

- **Unused lock, key & tag stored at a safe place in each department**

- **Spare common keys shall be kept by Shift Manager or equivalent for use during emergency**

EI :Competency & Training

	Energy isolation 1 day	Energy Isolation Refresher ½ day
Approving Authority / Supervisor (AA)	✓	✓
Approving Authority Representative (AAR)	✓	✓
Receiving Authority (RA)	✓	✓
Receiving Authority Representative (RAR)	✓	✓
Work Leader (WL)	✓	✓
Management Awareness Training (no test)		✓

- **Passing mark of 85% minimum out of 20 multiple choice questions (30 minutes)**
- **Refresher training (half day) every 3 years**
- **Awareness training for those managing isolation of energy activities (half day – every 3 years)**

**You can Help to create An Accident
Free Workplace Through LOTO**

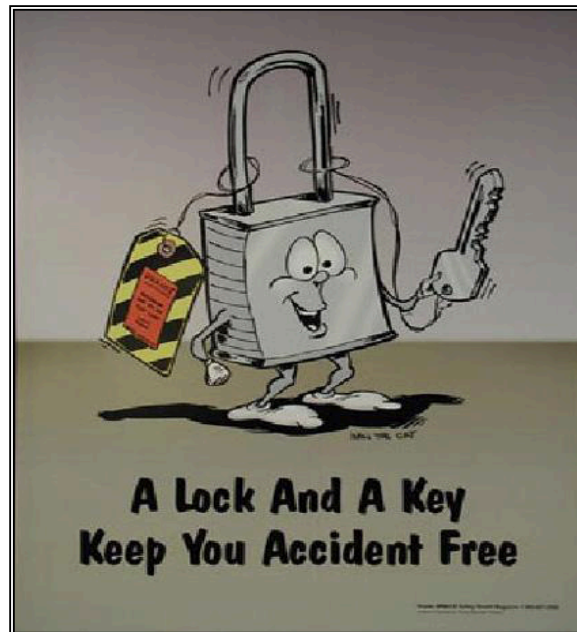

Thank You