



Electrical Installations & Wiring Non- Compliance Practices

Date: 28th August 2019 (Wednesday)

Time: 12:15 – 12:45 pm

Venue: Hotel Grand Riverview, Kota Bharu

Ir. Kok Yen Kwan

ACSB Accredited Engineer, Competent Elect. Engineer
PEPC, MIEM, CEng, MIET, MCIBSE, ASEAN Eng., REEM

email: yenkwan2@gmail.com

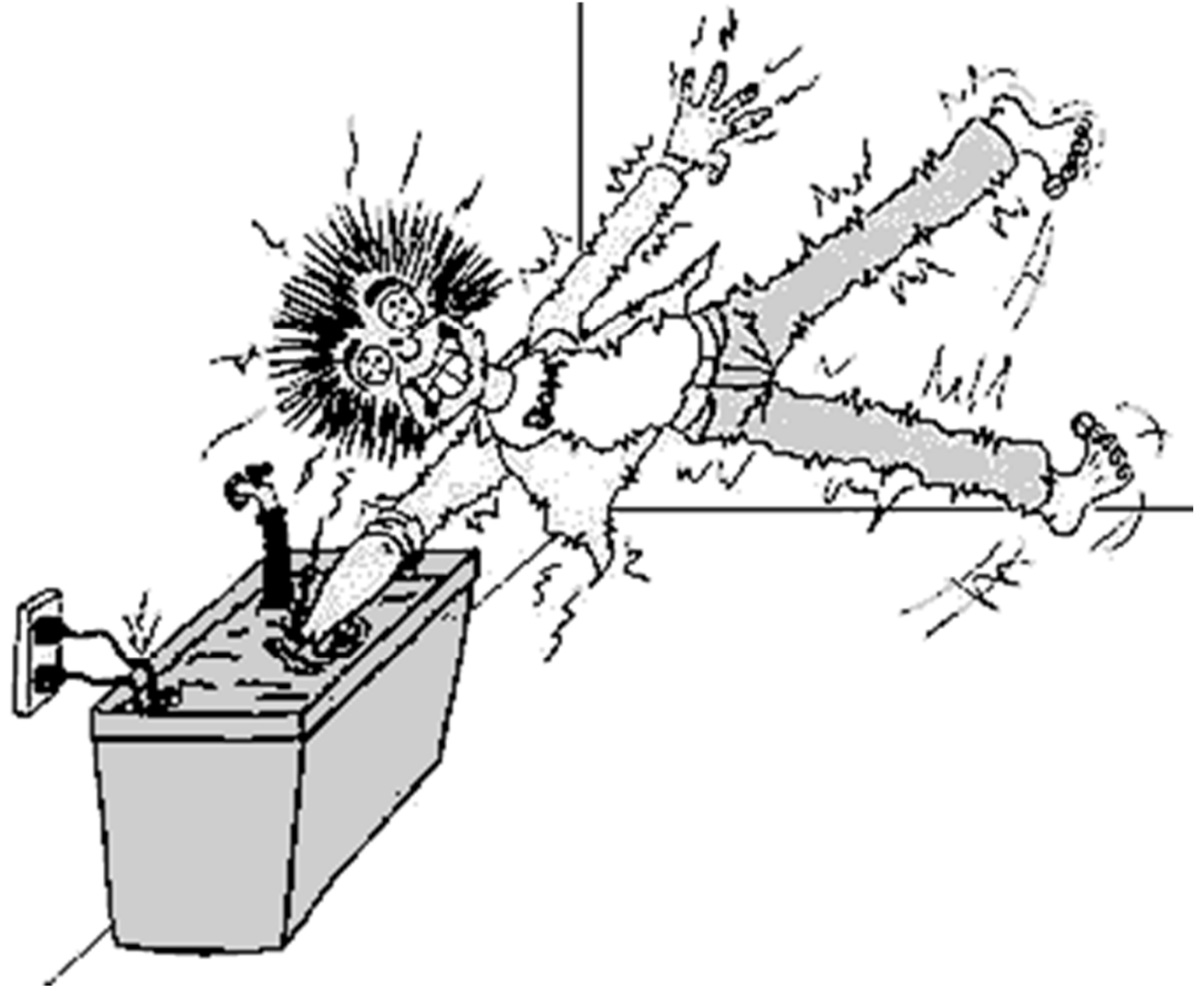

Take safety precautions

By Hariz Mohd - March 6, 2017 @ 10:18am

Share this story   



(File pix) A couple and their two sons, aged between 17 and 58, killed in a house fire in USJ 2, Subang Jaya.

Feb 6: A couple and their two sons, aged between 17 and 58, killed in a house fire in USJ 2, Subang Jaya;

Feb 14: Two girls aged 7 and 10, and their family's 29-year-old maid killed in another house blaze in Kepong; and,

Feb 18: Eight children between 8 and 16 years old killed when a car ploughed into them while cycling along the Middle Ring Road in Johor Baru, Johor.

In just a span of 12 days, 15 lives were lost in three separate tragedies, leaving their families to mourn their loss. These are memories too painful to forget. The abrupt passing of loved ones just does that. I, too, had lost a dear uncle in a hit-and-run accident, and several friends in road tragedies.

As a Muslim, I believe that our lives, and when and how we go are in God's hands. But, with all due respect to those who perished and their families, those who share the sentiment that these incidents are rather fated, as well as authorities investigating the cases, the human factor behind these incidents should be a lesson for us all.

The lackadaisical attitude of Malaysians towards safety is something that has been a bane of authorities, who have campaigned relentlessly to create awareness so that the public will take precautions for the sake of their safety and security. While I was covering the Feb 14 tragedy, the Federal Fire and Rescue Department assistant director-general (Investigation Division) Edwin Galan Teruki had, without directly disclosing their early findings into the fires, advised the public on electrical appliance safety and the crucial need for home owners to have smoke detectors and fire extinguishers.



 **BERNAMA.com**

English | Malay | Mandarin | العربية | Español

 ABOUT BERNAMA **GENERAL** POLITICS BUSINESS SPORTS

Breaking News / Berita Tergempar

GENERAL > NEWS



33 Cars And One Superbike Destroyed In Fire At Sg Buloh

SUNGAI BULOH, March 27 (Bernama) – Thirty-three cars and a high-powered motorcycle were destroyed in a fire at the parking lot of the Villamas Condominium, Jalan Sierramas Barat, here, early today.

Shah Alam Zone Senior Fire Superintendent I, Yusri Basri said firemen arrived at the scene at 5.43 am, and doused the fire by 7.57 am.

"We faced some difficulty in trying to control the raging fire as there was no water supply from the fire hydrant at the condominium, apart from there being no proper ventilation," he told reporters, here.

He said the fire-fighting operation involved 27 members and officers and five fire-engines from the Sungai Buloh, Damansara, Selayang and Shah Alam stations.

School wall falls, pupil hurt



BY R.S.N.MURALI

Nation Home > News > Nation

Facebook | Twitter | Google+ | LinkedIn | Print | Email



Damaged: A fireman talking to school officials at the scene.

MALACCA: A Year Two pupil suffered injuries after the wall of a classroom at SRK Jasir collapsed on her.

In the 12.50pm incident, eight-year-old Nurul Izatul Amira Zakaria was walking along the corridor when the wall suddenly came crashing down.

Preliminary findings revealed that strong winds caused the wall collapse.

The victim who suffered abrasions on her back and hands was rushed to Jasir Hospital but was allowed to return after treatment.

State Education, Higher Learning, Science and Technology committee chairman Datuk Wira Md Yunus Husin said the school administration was shocked over the incident.

"This incident shouldn't have occurred as the building structure would have been evaluated before being approved," he said when interviewed.

Md Yunus said it was shocking that strong winds could cause a solid wall to collapse.

"Let us wait for the full report from Public Works Department on the cause of the incident and decide on further action against those responsible," he said, adding that the heavy gust of wind was experienced in most parts of Malacca yesterday.

Cases of school structures collapsing is rare but it has occurred in the country.

Late last year, a school in Sarawak was on the verge of sliding into a river running by the school compound because of erosion.

The pupils had to be relocated due to safety issues.

Student electrocuted to death while taking shower

By **Bernama** - July 27, 2016 @ 12:30am

SEREMBAN: A Korean university student died after she was believed to have been electrocuted in a bathroom of her family home at Garden Homes, Seremban 2, here, yesterday.

Seremban police chief ACP Muhamad Zaki Harun said the incident occurred about 11 pm while Lee Xing Ni, 19, who was home for the semester break, was taking a shower.

"There was scalding on her left chest, believed as a result of the electrocution, The body was sent to Tuanku Jaafar Hospital, Seremban, and the outcome of the post-mortem found the cause of death was due to electrocution," he said in a statement today.

He said police ruled out foul play and classified the case as sudden death.

Lee was scheduled to return to Korea on July 31 to continue with her studies in Mass Communication. - Bernama



A Korean university student died after she was believed to have been electrocuted in a bathroom of her family home at Garden Homes, Seremban 2, here, yesterday. Seremban police chief ACP Muhamad Zaki Harun said the incident occurred about 11 pm while Lee Xing Ni, 19, who was home for the semester break, was taking a shower. (Bernama photo)

Gruesome but TRUE !



electrical shocks & us

Effects of Electricity on Humans

AC current (mA)	Effect on human body
1	Slight tingling sensation
2-9	Small shock
10-24	Muscles contract causing you to freeze
25-74	Respiratory muscles can become paralysed; pain; exit burns often visible
75-300	Usually fatal; ventricular fibrillation; entry & exit wounds visible
>300	Death almost certain; if survive will have badly burnt organs and probably require amputations

source: www.dmp.wa.gov.au

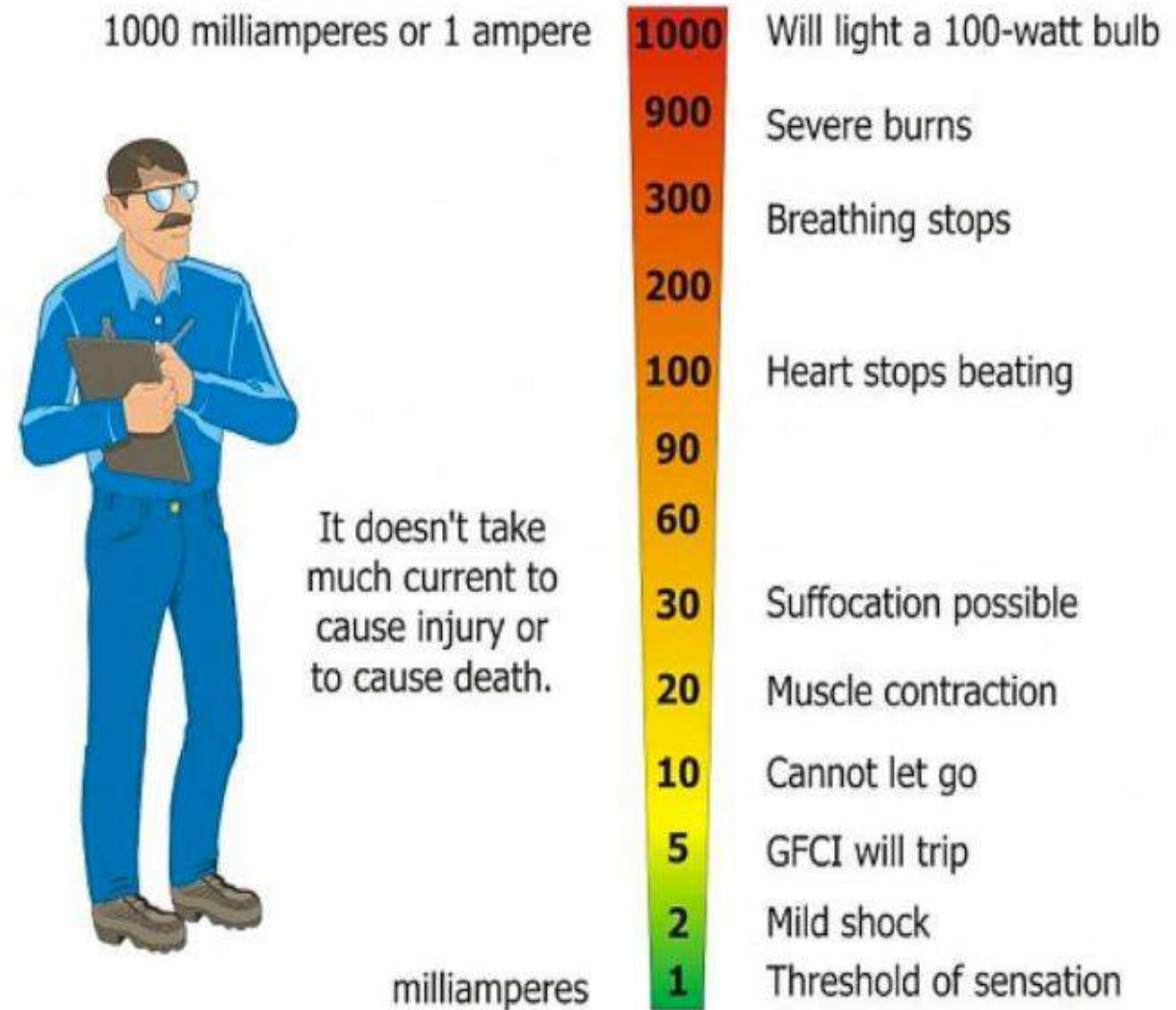

survival rates

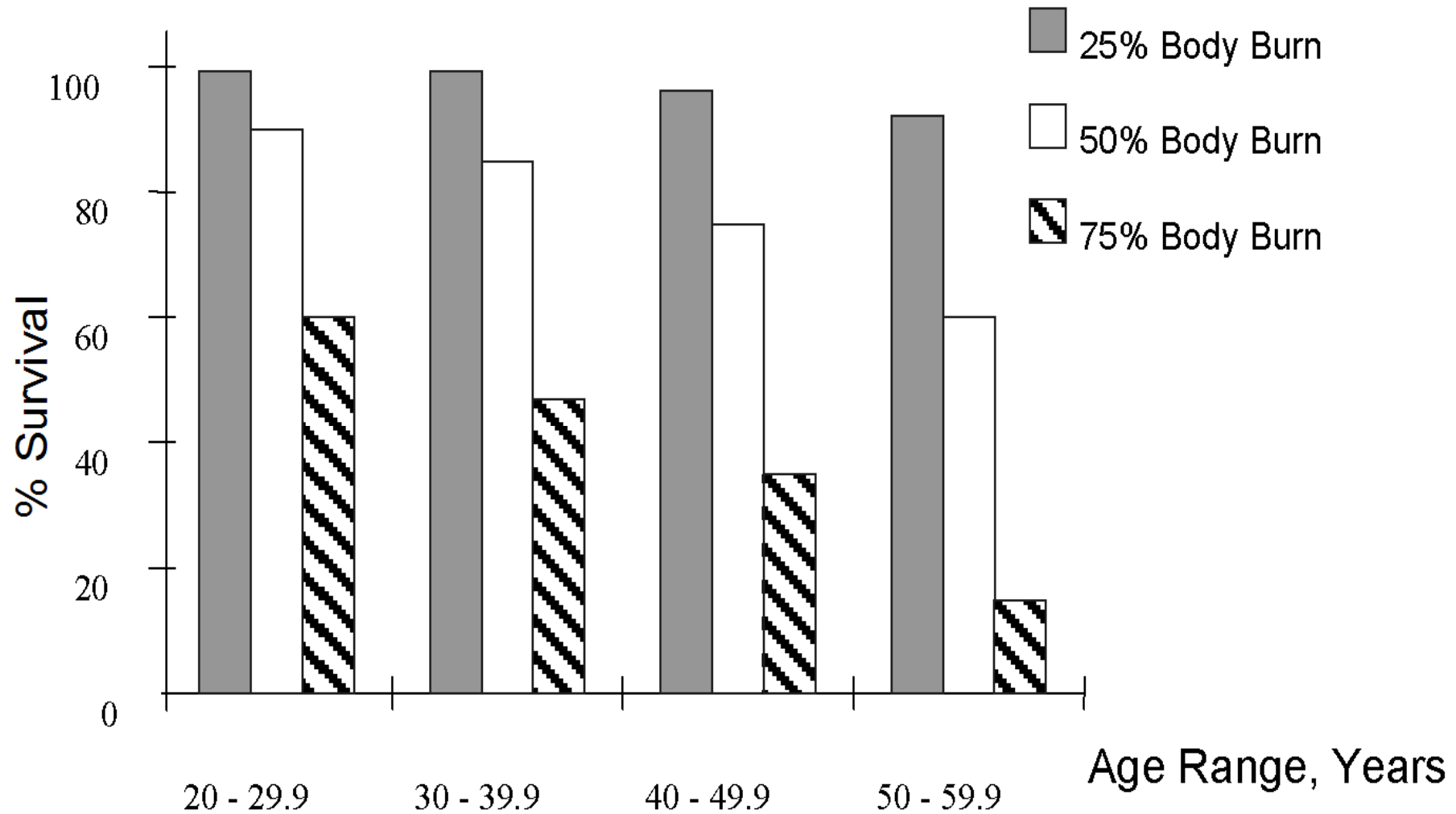

source: www.ameriburn.org

the main causes

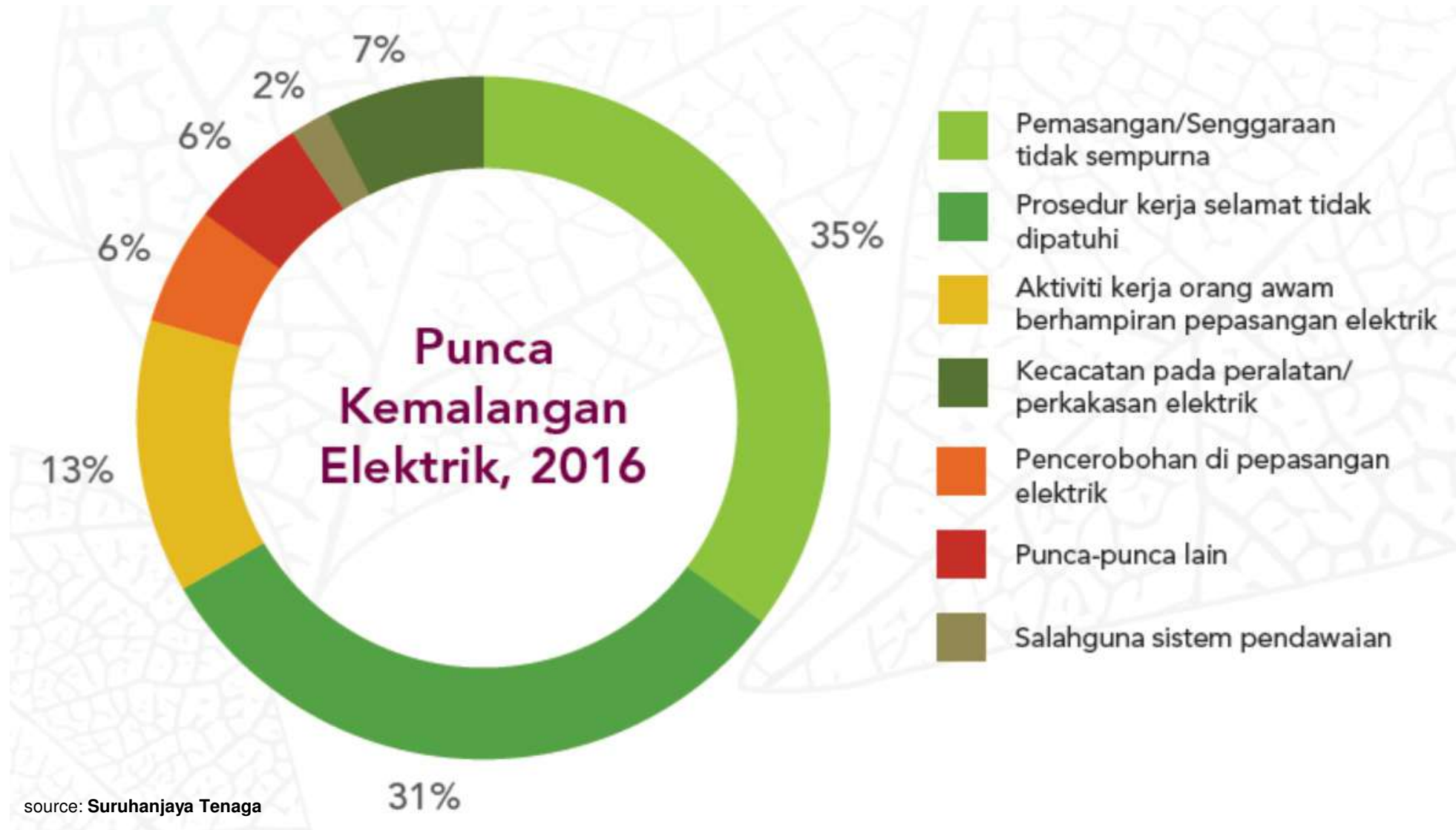

legislation compliance

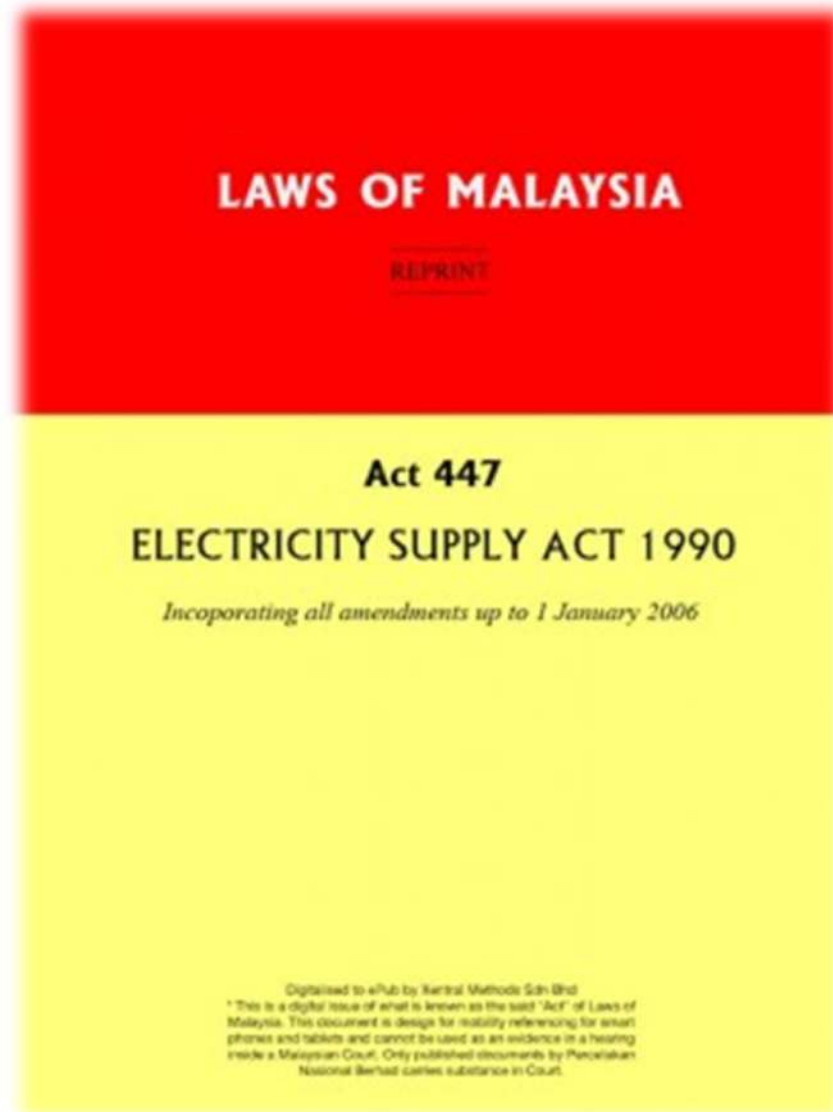

ELECTRICITY REGULATIONS 1994

IN exercise of the powers conferred by section 53 of the Electricity Supply Act 1990 [Act 447], the Minister makes the following regulations.

PART 1 - PRELIMINARY

Regulation 1. Citation and commencement.

(1) These regulations may be cited as the Electricity Regulations 1994 and shall, subject to subregulation (2), come into force on the 30th January 1994.

(2) Subject to subregulation (1), the following regulations shall come into force on the 30th January 1996.

- (a) regulation 13;
- (b) subregulations 23(2), 23(3) and 23(4);
- (c) paragraph 78(2)(c);
- (d) paragraph 78(3)(c);
- (e) paragraph 78(4)(c);
- (f) paragraph 78(5)(c);
- (g) paragraph 81(c);
- (h) paragraph 85(c);
- (i) regulation 88; and
- (j) regulation 57.

Regulation 2. Interpretation.

In these Regulations, unless the context otherwise requires—

"accessory" means a device, other than current-using equipment, associated with such equipment or with the wiring of an installation;

"apparatus" means any electrical apparatus and includes the device or fitting in which a conductor is used, or of which it forms part of;

4 basic wiring requirements



(1) Mechanical Protection

Place all electrical wiring & cable assemblies inside of an approved metal or plastic electrical conduit.

4 basic wiring requirements

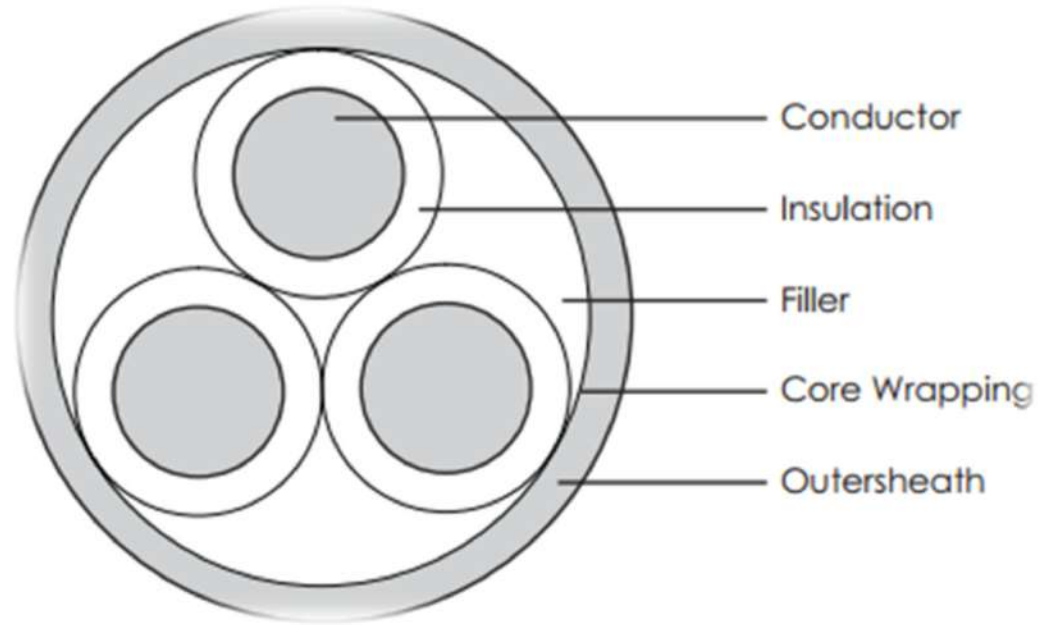

(2) Insulation

Electrical wiring to be run in conduit comes in individual strands, encased in insulation to protect the wire & insulate it from other wire & the conduit.

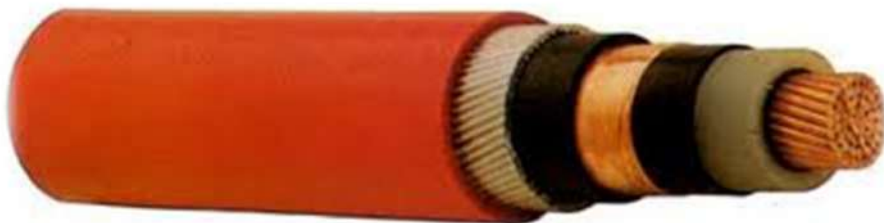

4 basic wiring requirements

(3) Continuity

In electrical applications, when an electrical circuit is capable of conducting current, it demonstrates electrical continuity. It is also said to be “closed” because the circuit is complete.

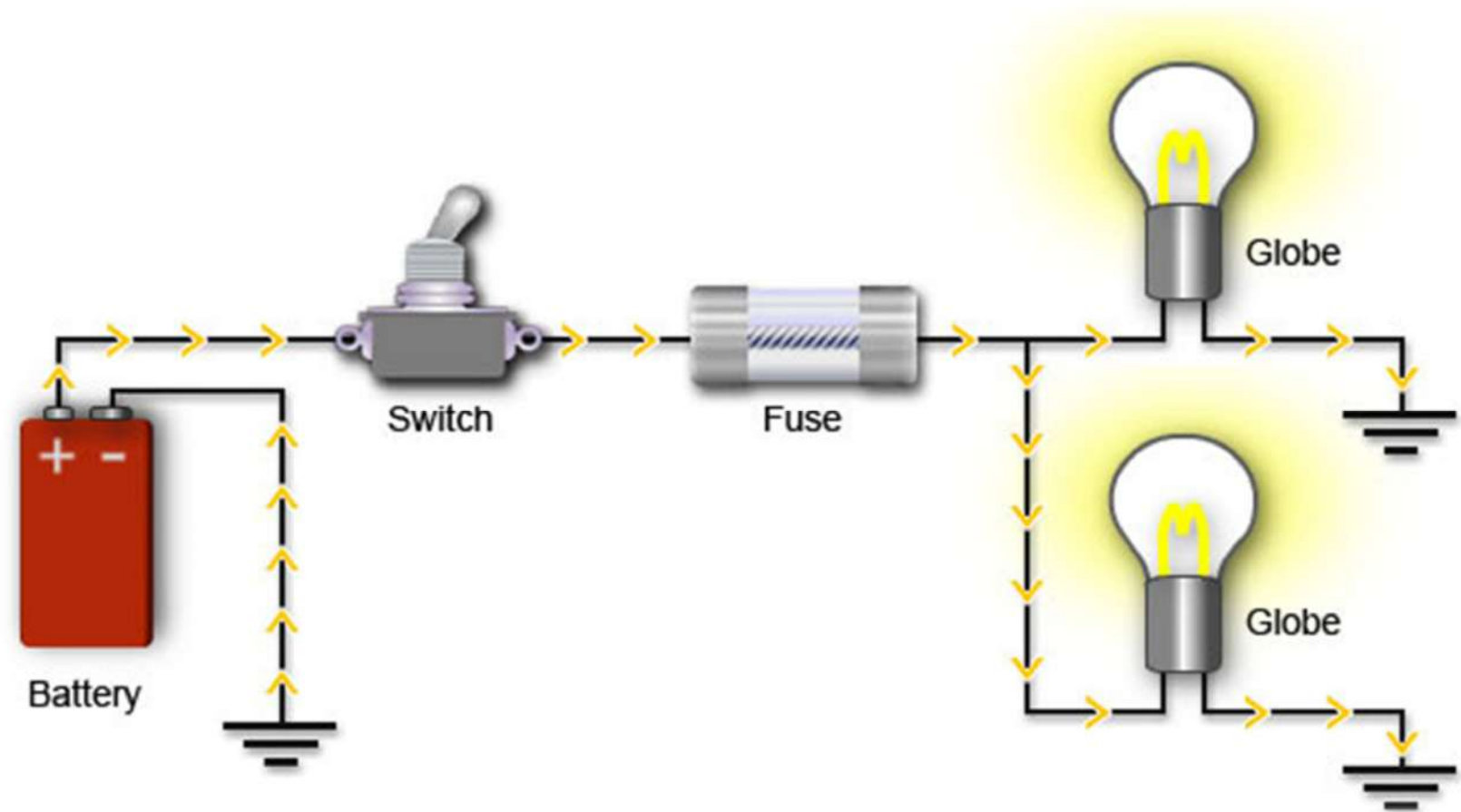

4 basic wiring requirements



(4) Strength

The cable strength refers to the force where the cable can be sustained before it break.



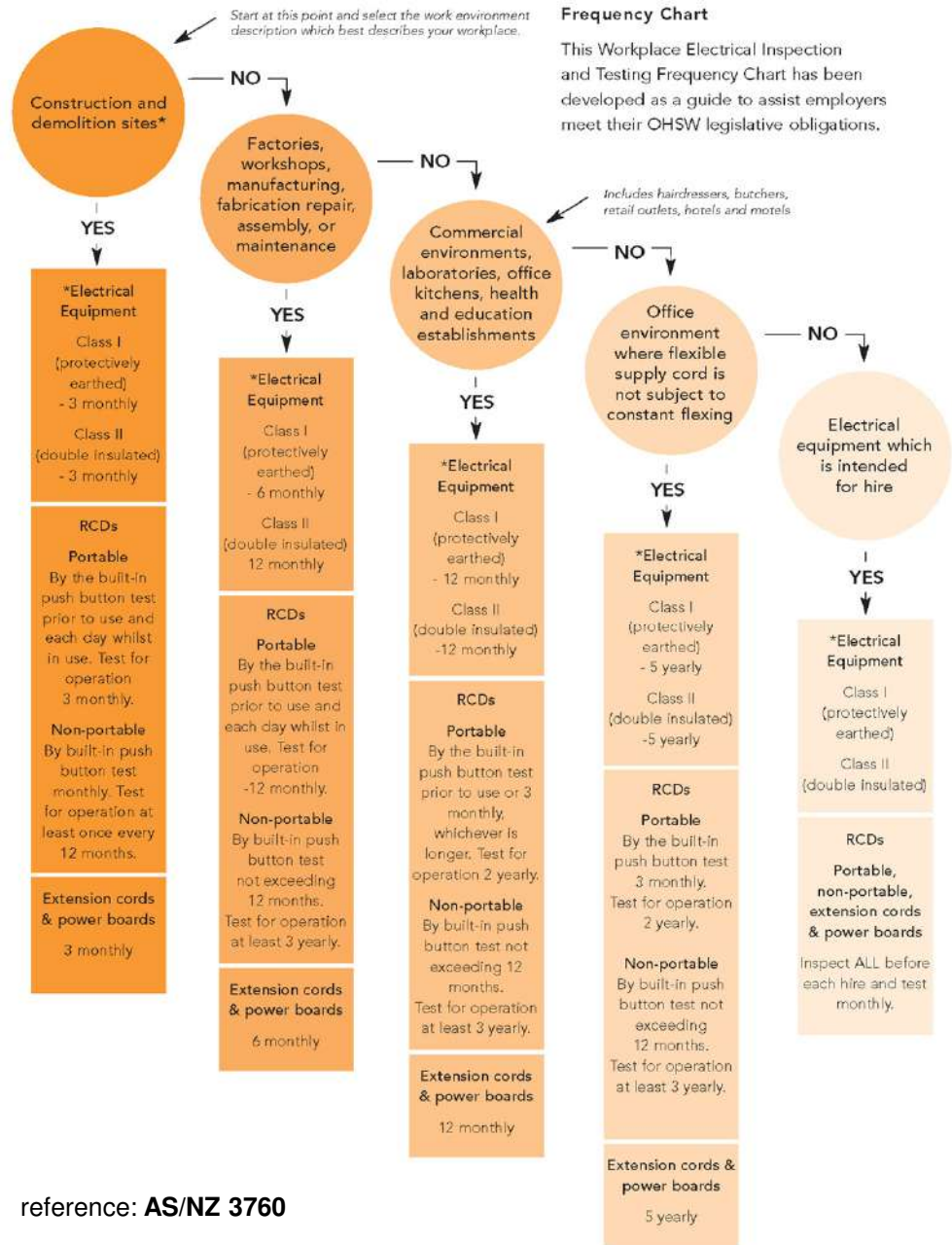

*test
 schedule:
 do you
 have
 one?*

reference: AS/NZ 3760

KISAH BENAR series: Lack of Signage



KISAH BENAR series: Protection Relays not commissioned



KISAH BENAR series: **Everything is in Order!**



KISAH BENAR series: **non-compliance wiring work**



**proper
installation**

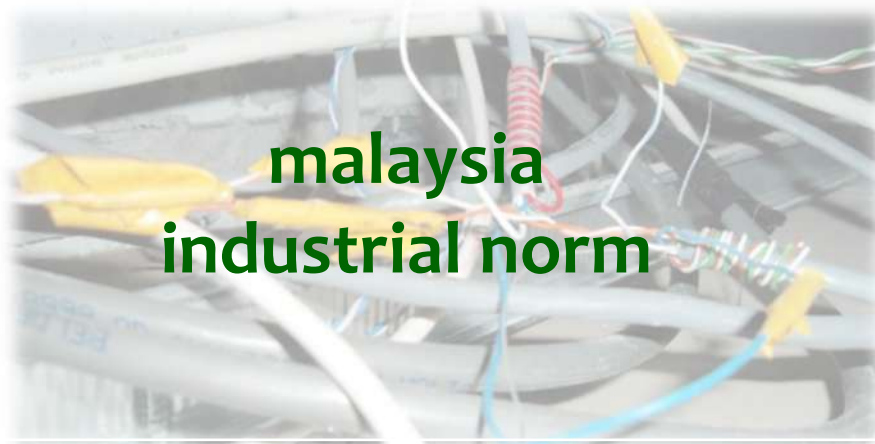

**malaysia
industrial norm**



**malaysia
industrial
norm**

KISAH BENAR series: unsafe installation work

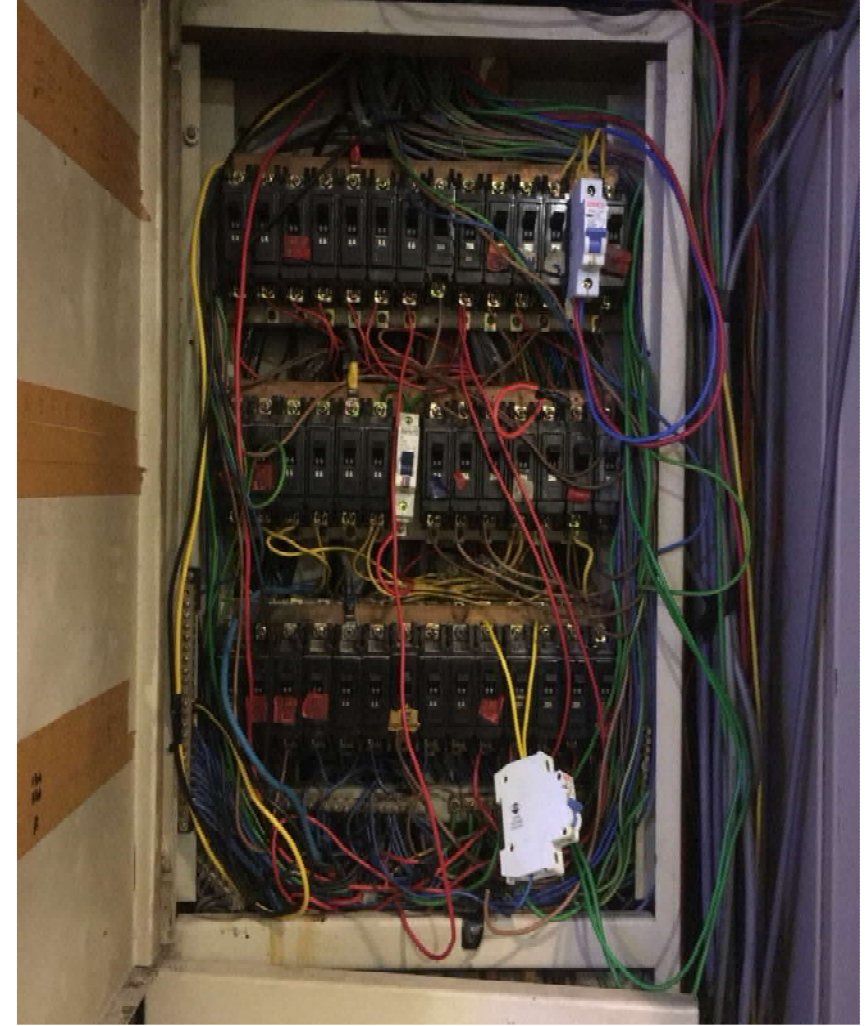

KISAH BENAR series: *more non-compliance work*

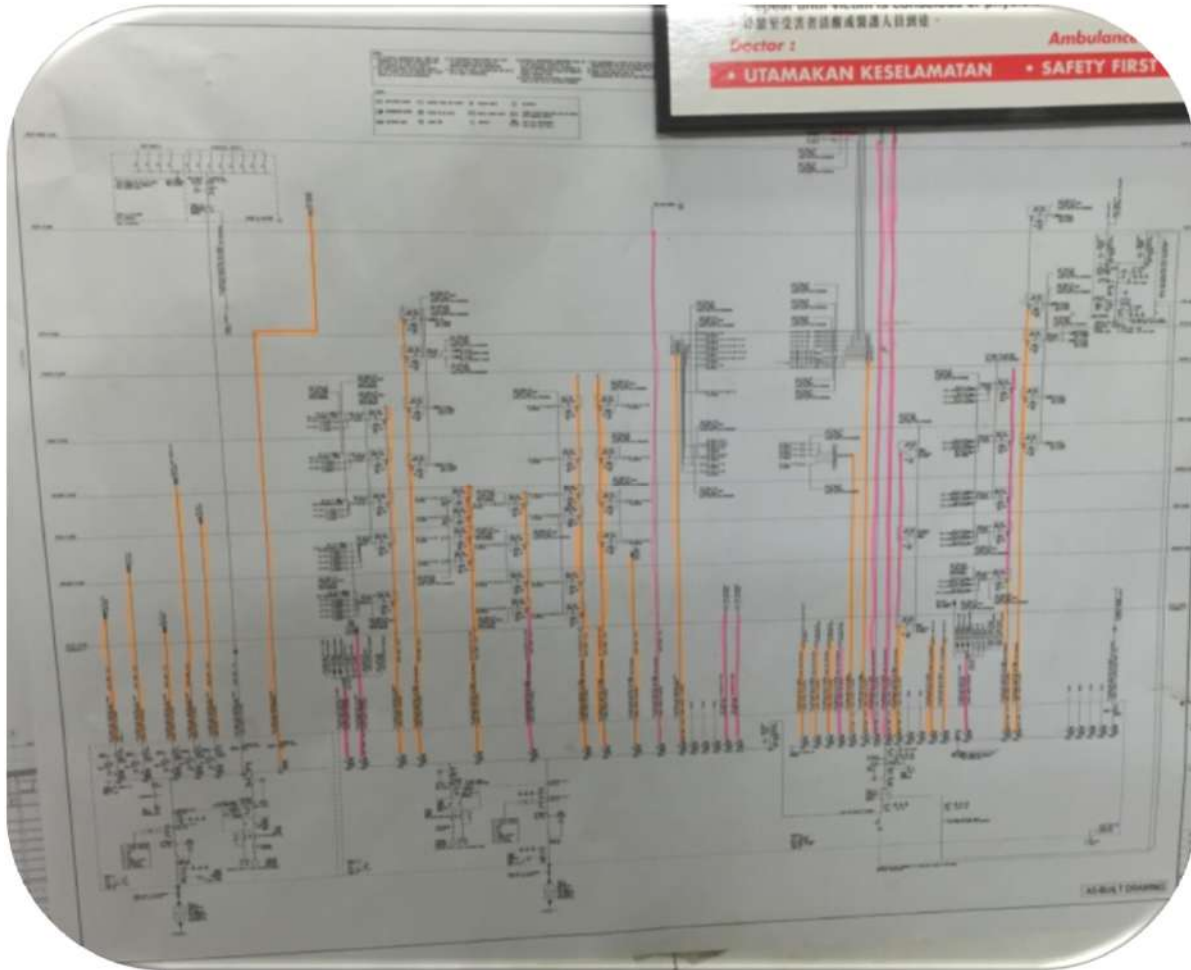

KISAH BENAR series: *more non-compliance work*

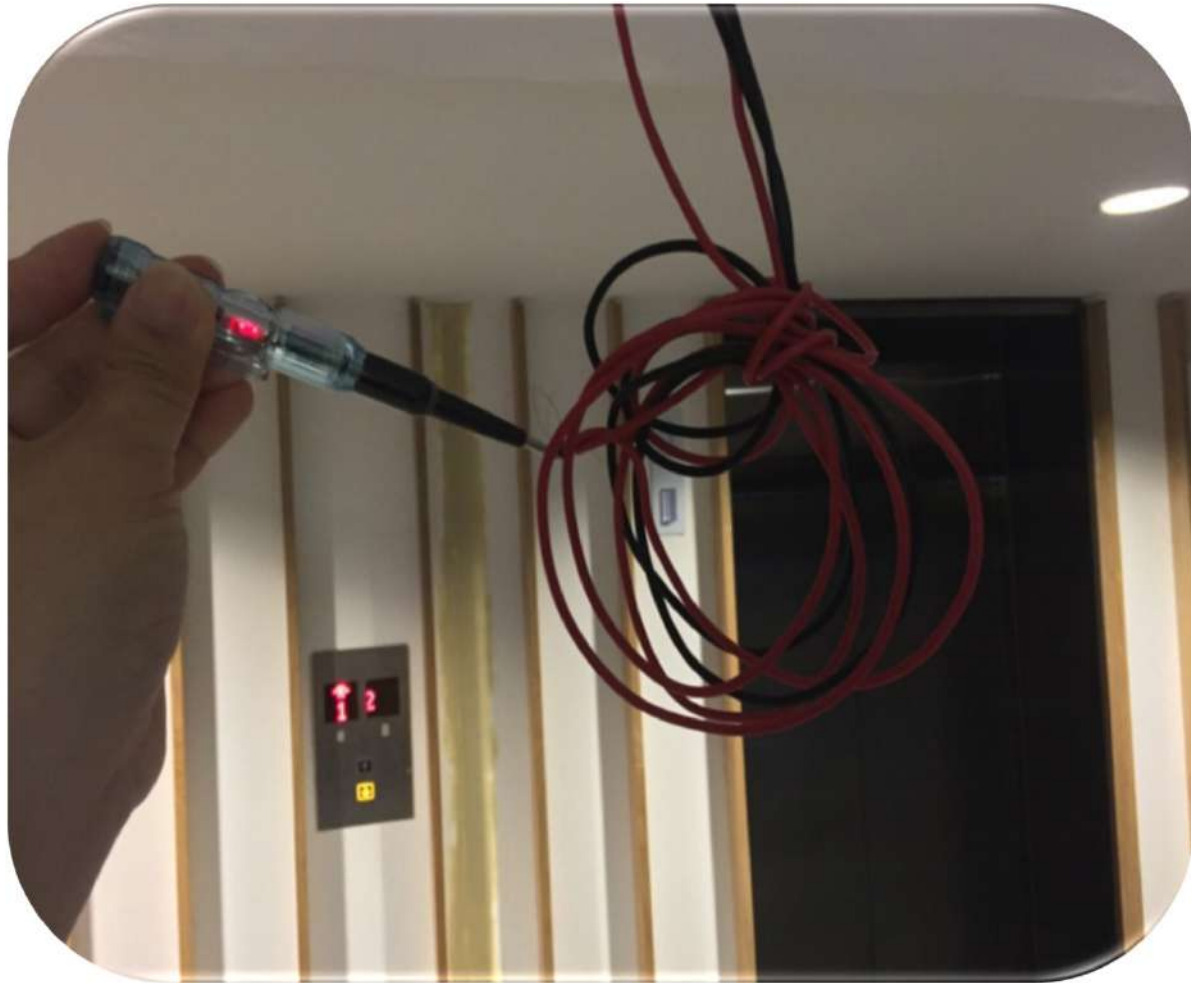

KISAH BENAR series: *more non-compliance work*



comparing to these: *Best Practices...*



Residual Current Device: *how it works...*

An RCD is designed to trip within nominated leakage current, and thus saving livestock.
Without RCD, the current (i) will flow through, killing you!

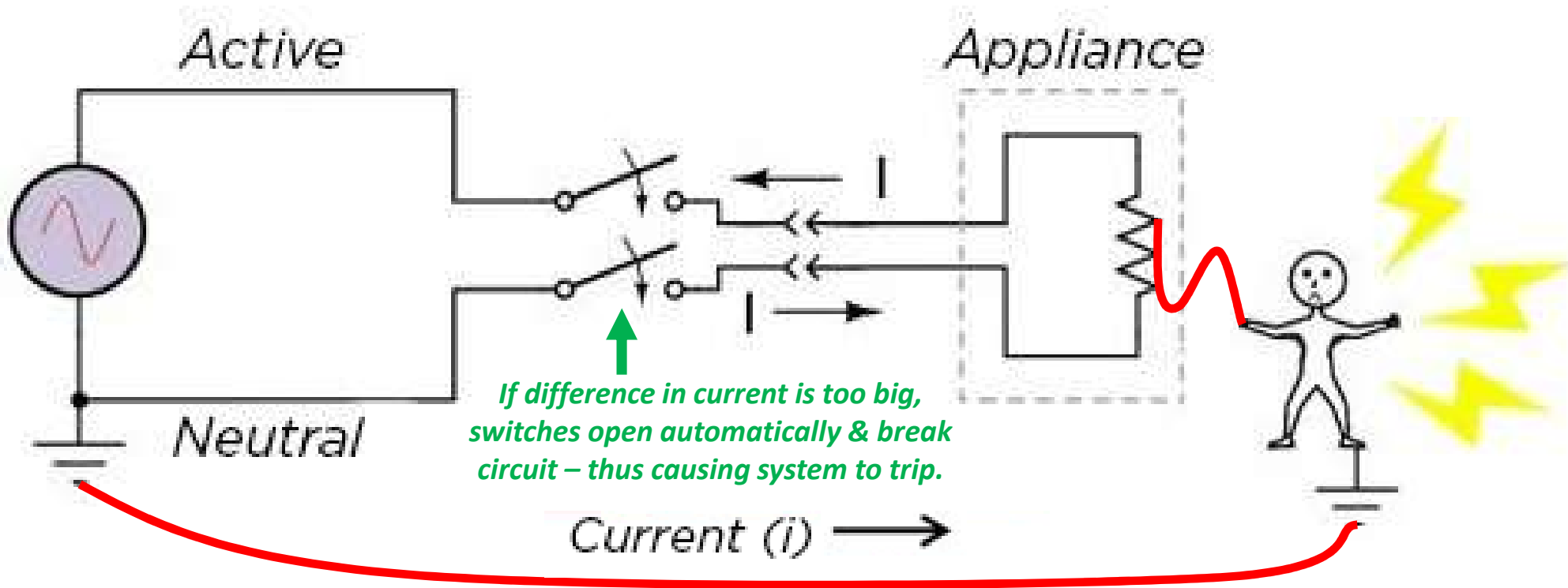

source: Electrician Courses 4U (EC4U)

RCD: *selections & areas of protection*

RCD is used to protect both live-stocks and assets from the following three (3) conditions: -

(a) Protection against fire,



(b) Protection against Indirect Contact (Fault Protection),

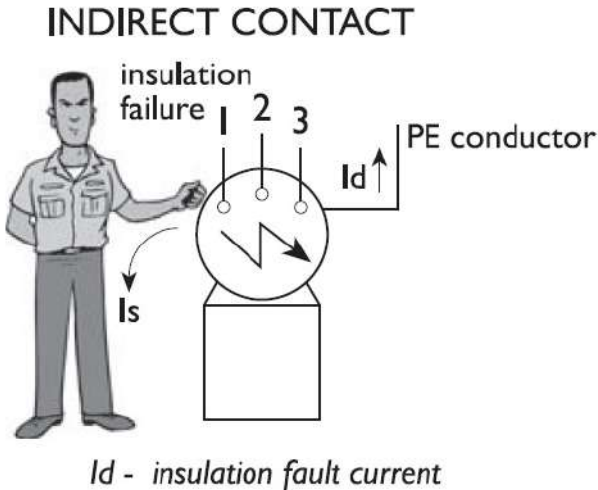

(c) Protection against Direct Contact (Basic Protection).

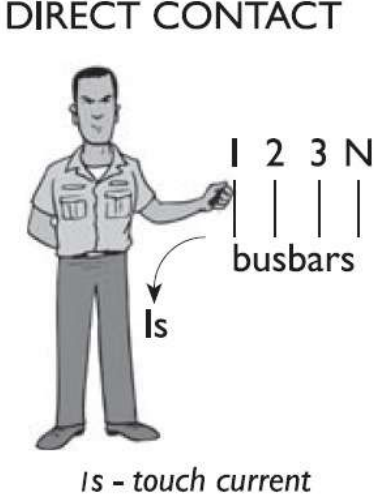

RCD: *compliance to Clause 36 (ER 1994)*

Clause 36(1): For an installation in a place of public entertainment, protection against earth leakage current shall be afforded for any final circuit supplying electricity to an equipment which is intended to provide service to the public or which is intended to be accessible to, used by or operated by the public by a residual current device having a rated residual operating current **< 10 mA**.

Clause 36(2): For an installation in a place where the floor is likely to be wet or where the wall or enclosure is of low electrical resistance, protection against earth leakage current shall be afforded for any final circuit supplying electricity to any equipment, either individually or in a group, by a residual current device having a rated residual operating current **< 10 mA**.

Clause 36(3): For an installation where hand-held equipment, apparatus or appliance is used or is likely to be used, protection against earth leakage current shall be afforded for any final circuit, either individually or in a group, by a residual current device having a rated residual operating current **< 30 mA**.

Clause 36(4): For an installation, other than the installations mentioned in sub-regulations (1), (2) and (3), protection against earth leakage current shall be afforded for any final circuit, either individually or in a group, by a residual current device having a rated residual operating current **< 100 mA** unless: -

- (a) for functional reasons, it is impractical to provide the protection; or
- (b) it is unsafe or even dangerous to provide the protection.



ST Guidelines on Residential Wiring



GUIDELINES FOR ELECTRICAL WIRING IN RESIDENTIAL BUILDINGS

2008 EDITION
www.st.gov.my

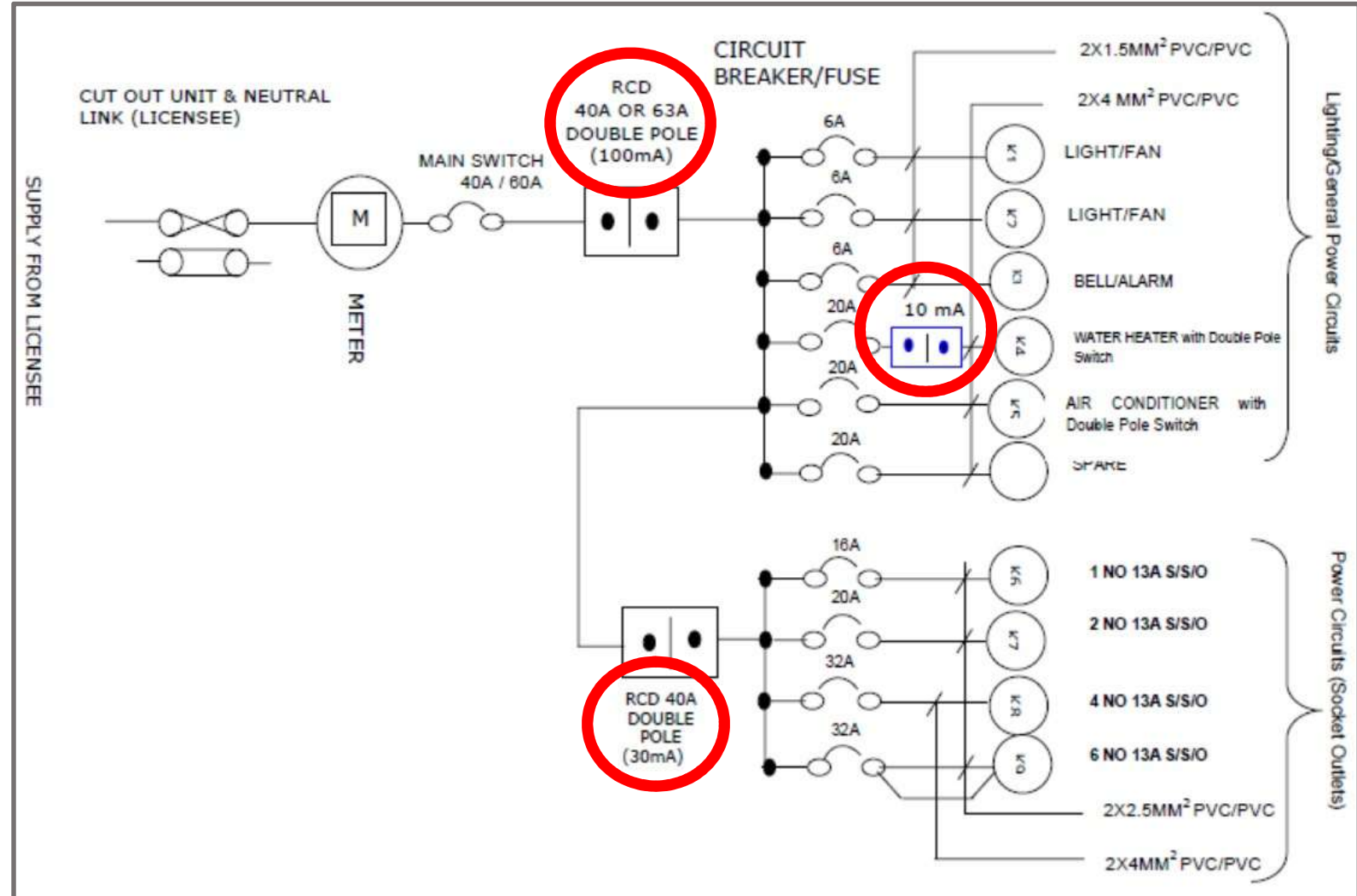

LATEST: Implementation of *Electrical Safety Management System*



Ruj. kami :
Tarikh : 10/3/17

Kepada yang berkenaan

Tuan,

**PERLAKSANAAN SISTEM PENGURUSAN KESELAMATAN ELEKTRIK
(ELECTRICAL SAFETY MANAGEMENT SYSTEM) SELARAS DENGAN
PERUNTUKAN SEKSYEN 33B, AKTA BEKALAN ELEKTRIK 1990**

Dengan segala hormatnya adalah merujuk kepada perkara diatas.

2. Untuk makluman tuan, selaras dengan **Seksyen 33B, Akta Bekalan Elektrik 1990** iaitu *seorang pemunya atau pengendali pemasangan elektrik bukan domestik yang berdaftar di bawah akta ini dan pemegang lesen bagi pemasangan persendirian hendaklah mematuhi kod keselamatan pemasangan elektrik bukan domestik dan program pengurusan keselamatan, atau jika tiada apa-apa kod atau program itu, dengan standard dan amalan industri yang berhemat sebagaimana yang ditentukan oleh Suruhanjaya Tenaga.*



GUIDELINE ON
ELECTRICAL
SAFETY
MANAGEMENT
PLAN AND PROGRAMME



REMEMBER THIS!

**SAFETY
FIRST**

**THE SAFE WAY IS
THE BEST WAY**

*ELECTRICAL SAFETY
is NOT an option,
ELECTRICAL HAZARDS
exist almost everywhere!*

END OF PRESENTATION

- Thank You -