

Analysis and Impact of Substandard Cables to the Industries and Consumers

Tee Kok Hwa
TC Chairman

Fires Statistic for year 2012

STATISTIK PUNCA-PUNCA KEBAKARAN BANGUNAN
 BAHAGIAN PENYIASATAN KEBAKARAN
 JABATAN BOMBA DAN PENYELAMAT MALAYSIA
 TAHUN 2012
 SELURUH MALAYSIA - Januari hingga Jun

KOD	KATEGORI BANGUNAN	PENGKELASAN PUNCA KEBAKARAN																					JUMLAH SIASATAN	
		SEMULAJADI	KEMALANGAN											SENGAJA DIBAKAR										TIDAK DAPAT DIPASTIKAN
			SUMBER NYALAAAN																					
		SN1	SN2	SN3	SN4	SN5	SN6	SN7	SN8	SN9	SN10	SN11	SN3	SN4	SN5	SN6	SN7	SN8	SN9	SN10	SN11			
B1	Kilang / Bengkel	3	5	50	16	9	15	17	2	4	20	8	0	0	0	6	1	0	0	0	1	9	166	
B2	Pejabat	2	0	49	14	1	5	5	0	0	0	1	0	0	0	6	0	0	1	0	0	3	87	
B3	Kediaman	28	8	434	122	0	399	106	6	0	15	107	0	0	0	73	1	0	0	1	9	69	1,378	
B4	Kedai	2	2	100	42	1	62	17	1	0	1	11	0	0	0	21	1	0	0	0	1	16	278	
B5	Sekolah	7	0	31	13	0	4	3	0	0	1	4	0	0	0	3	1	0	0	0	1	2	70	
B6	Pusat Membeli Belah	0	0	4	1	0	0	2	0	0	1	1	0	0	0	0	0	0	0	0	0	0	9	
B7	Stor / Gudang	1	0	31	4	0	14	6	0	0	0	4	0	0	1	3	0	0	0	0	0	2	66	
B8	Dewan Perhimpunan	0	1	9	3	0	4	1	0	0	0	0	0	0	0	3	0	0	0	0	0	0	21	
B9	Hospital / Klinik	0	0	4	5	0	2	0	0	2	2	0	0	0	0	1	0	0	0	0	0	1	17	
B10	Asrama / Hotel	2	1	17	5	0	6	3	0	0	1	1	0	0	0	3	0	0	0	0	0	1	40	
B11	Stesen Minyak	0	0	3	1	0	0	0	0	0	1	0	0	0	0	0	0	0	0	0	0	1	6	
B12	Struktur Khas	0	0	11	6	1	3	4	0	0	2	0	0	0	0	2	0	0	0	0	1	0	30	
B13	Lain-lain Bangunan	1	4	66	8	0	21	10	0	1	5	18	0	0	0	6	0	0	0	0	2	7	149	
JUMLAH		46	21	809	240	12	535	174	9	7	49	155	0	0	1	127	4	0	1	1	15	111	2,317	

* Pengkelasan kategori bangunan yang terbakar adalah berdasarkan kepada tempat bermula kebakaran (Fire Origin) atau tempat yang paling teruk terbakar (Worst Damage)

Petunjuk : Sumber Nyalaaan

SN1	Kilat / Cahaya Suria	SN7	Api berbara (Glowing fire)
SN2	Tindakbalas spontan	SN8	Letupan
SN3	Kegagalan sistem pendawaian elektrik	SN9	Tindakbalas kimia
SN4	Kegagalan fungsi peralatan elektrik	SN10	Permukaan bahan berhaba tinggi (Hot surface material)
SN5	Kesan geseran / hentaman	SN11	Lain-lain
SN6	Api terbuka (Open flame)		

Danger in using inferior wires, says association

Items flooding the market of late do not conform to safety standards

KUALA LUMPUR, Wed: Thinking of rewiring your home, or office? Before you spend your money, take note that there has been an influx of substandard wires and cables flooding the market of late.

The Malaysian Electric Cable & Wires Association (Mecwa), the association representing Malaysia's wire and cable manufacturers, said today it will undertake a nationwide campaign to stamp out substandard cables and wires.

Mecwa president Datuk Kenneth H'ng said its members were aware of the increasing number of such home wires and cables in the market which do not conform to the quality and standards approved and recognised by the quality certification bodies.

"In addition, these cables are often packaged in short lengths duping the consumers into

thinking that he or she is buying 100m but is, in fact, receiving less," he said in a statement.

H'ng said the low quality cables are a danger to the public, and the association is determined to approach the government and the standards authorities to get the products off the shelves.

"Substandard cables are a safety hazard. Consumers are being cheated when they purchase poor quality, falsely labelled product."

He said the association will recommend to the government that all wire and cable manufacturers attain the ISO 9001/9002 quality standard accreditation and that the authorities approve renewals based on successful quality accreditation.

He said the association will meet with relevant authorities, including Sirim, on the matter. — Bernama

Killer sockets, deadly fuses

Fake Sirim stickers on electrical items sold to developers

ELECTRICAL components such as switches, plugs, sockets, fuses and cables are being sold in the market with fake Sirim certification stickers — and some are being sold to contractors and developers of huge housing projects, reported *Harian Metro*.

The paper said these products were manufactured illegally at workshops and sold to outlets to Sirim safety specifications.

Calling these "killer sockets" and "deadly fuses", the newspaper disclosed that such products

were the main cause of short circuits, "exploding" electrical products and fires at homes and shops.

Sirim and the Domestic Trade and Consumer Affairs Ministry made this shocking discovery in Kepong on Thursday.

One of the wholesalers found having the electrical items was a

Ministry and Sirim officials said they found it shocking that Sirim stickers were being faked and



Compiled by SHAHANAAZ HABIB, TAN SIN CHOW and A. RAMAN

used to deceive buyers into believing that the components were approved and safe. The newspaper reported that

one of the shop owners also admitted to the authorities that he had assembled the components at the back of his shop to save costs.

What was even more shocking, the report said, was that investigations showed that these unsafe electrical components were being sold to contractors and housing developers.

Under the law, the owner of the premise found to have falsified the Sirim logo can be fined up to RM250,000.



BAHAYA...antara soket dan wayar penyambung elektrik menggunakan pelekat Sirim dan Suruhanjaya Tenaga palsu yang dirampas.

ewujudan pelbagai komponen dan perkakas elektrik di rumah yang menggunakan ekat Sirim palsu kini mengancam nyawa ratusan ribu pengguna. Difahamkan, peralatan perti suis, fius, soket dan wayar penyambung bermutu rendah buatan pengilang haram juga tidak mendapat kelulusan Suruhanjaya Tenaga, lapor Mohd Jamilul Anbia Md Denin muka 6

THE STAR, SATURDAY 2 FEBRUARY

Association: Low quality wires flooding market

KUALA LUMPUR: The Malaysian Electric Cable and Wires Association has warned the public to be wary of sub-standard wires and cables flooding the market.

Association president Datuk Kenneth H'ng, in making this revelation yesterday, said it would carry out a nationwide campaign to stamp out these sub-standard house wiring cables which had begun appearing in the market.

He said association members were aware of the rising quantity of such cables in the market which did not conform to the standards of certification bodies.

"In addition, these undersized and sub-standard cables are often packaged in short lengths so that consumers may think they're buy-

ing 100m but are, in fact, getting less," he said in a statement.

H'ng said the low-quality cables were dangerous to the public and the association was determined to approach the Government and the standards authorities for help.

"Sub-standard cables are safety hazards, and in addition, the consumers are being cheated when they buy poor quality, falsely-labelled products," he said.

H'ng said the association would recommend to the Government that all wire and cable manufacturers attain the ISO 9001/9002 quality standard accreditation.

He also called on the authorities to approve renewals based on successful quality accreditation. — Bernama

Treasury, Malaysia – Circular Letter SPP Bil. 7 Effective June 5th 2002

- *Government agencies must ensure that specifications for local materials/goods used in all procurement exercise be based on Malaysian Standard (MS), issued by the Department of Standards Malaysia. If MS is not available for any particular materials/goods, other appropriate international standards or standards set by the Specifications Preparatory Committee of the agency concerned could be utilised*
- *Appropriate action including disciplinary action in the form of a “surcharge”, will be taken against Government agencies and their principal officers for failing to comply with the ruling*
- *Errant contractors and consultants failing to comply would be penalised including being blacklisted and not being considered for other Government projects*

- Satisfies **power** needs
- **Flexible**
- **Reliable**
- **Has long life**
- **Minimal maintenance**
- **Economic**

Sub Standard Cable

Cables which are not designed, constructed, test approved, installed or used in accordance to their prescribed standards and/or specifications

The development of national standards for electric cables takes into account the principles and norms as established internationally, current prevailing conditions and local practices. It is important to understand that these aspects are majorly unbeknown to buyers and users, hence failure to comply on critical aspects may present an undetermined risk on safety.

Cable Construction

General Cable Construction 1kV ~ 35 kV, Copper / Al Conductor

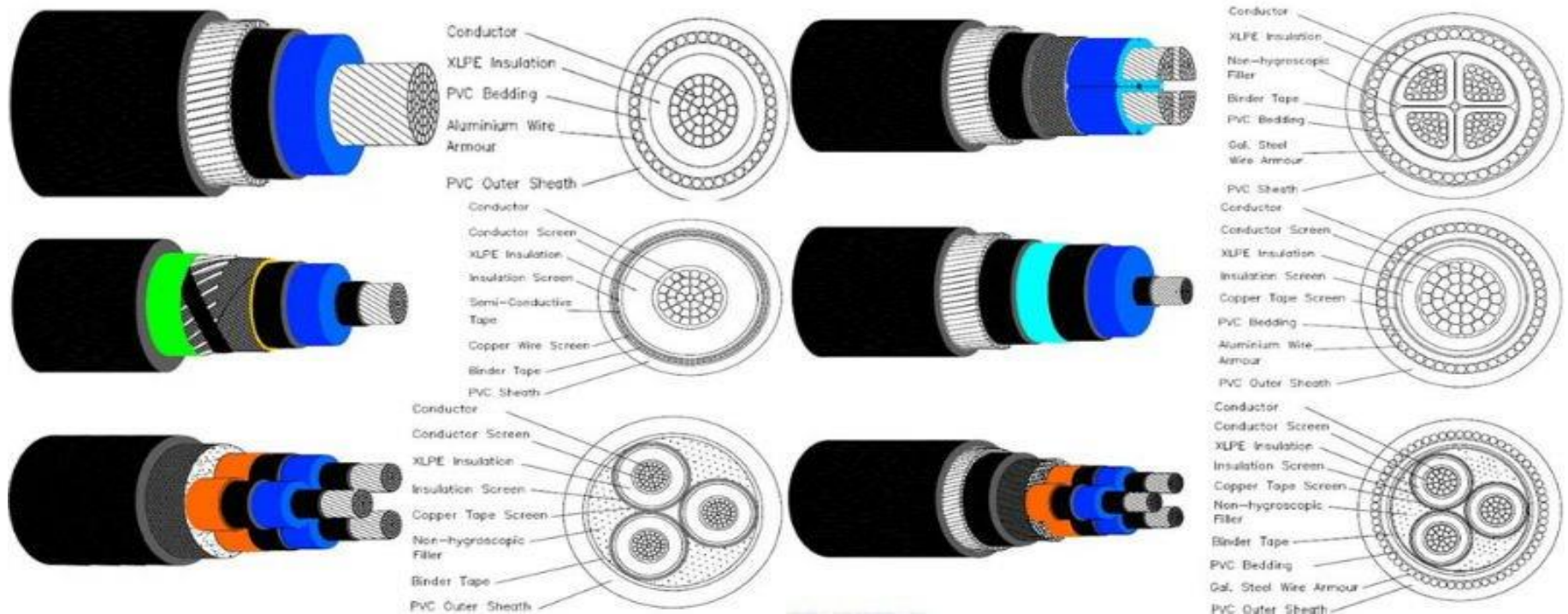

Conductor

→ Determine the current rating

Insulation

→ *Determines voltage / stress levels*

Protective layers

→ *Determines protection level & installation conditions*

Cable Risk Assessment

Um (max voltage)	Class	Ref Stds & Specifications		Risk	Control on Quality & Inspection
		Existing/Prev	New		
Above 170kV	EHV	Utility	Utility	Nil	High scrutiny at all levels
37kV - 170kV	HV	IEC/Utility	IEC/Utility	VLow	High sampling rate of test & inspection
3.7kV - 36kV	MV	BS/IEC/Utility	IEC/MS	Low	Adequate control on test & inspection
1.2kV - 3.6kV	LV	BS/IEC/Owner	IEC/MS	Low	Adequate control on test & inspection
Below 1.2kV	ELV	BS/MS	MS	High	Minimum or no control

MV, HT & EHV Cable



Um (max voltage)	Class	Ref Stds & Specifications		Control on Quality & Inspection	Risk
		Existing/Prev	New		
Above 170kV	EHV	Utility	Utility	High scrutiny at all levels	Nil
37kV - 170kV	HV	IEC/Utility	IEC/Utility	High sampling rate of test & inspection	VLow
3.7kV - 36kV	MV	BS/IEC/Utility	IEC/MS	Adequate control on test & inspection	Low
1.2kV - 3.6kV	LV	BS/IEC/Owner	IEC/MS	Adequate control on test & inspection	Low

LV Cable Below 1KV



Um (max voltage)	Class	Ref Stds & Specifications		Control on Quality & Inspection	Risk
		Existing/Prev	New		
Below 1.2kV	ELV	BS/MS	MS	Minimum or no control	High

MS 2112 consists of the following parts, under the general title *Electric cable and wire - PVC insulated cables of rated voltages up to and including 450/750 V*:

Part 1: General requirements

Part 2: Test methods

Part 3: Non-sheathed cables for fixed wiring

Part 4: Sheathed cables for fixed wiring

Part 5: Flexible cables

Part 6: Cables for lift and flexible connections

Note : All cable types of conductor sizes up to and including 35 mmsq are controlled items under the Suruhanjaya Tenaga Malaysia

Controlled Items under Suruhanjaya Tenaga

Category 31 – Wires / Cables / Cords

CATEGORY	ITEM DETAILS	REF STDS (Prev)	NEW MS
Category 31 - WIRES / CABLES / CORDS 0.5 to 35 sqmm	Insulated flexible cords and cables	MS 140 : 1987	Electric Cable and Wire - Polyvinyl Chloride (PVC) Insulated
	PVC insulated cable (non-armoured) for electric power supply	MS 136 : 1987	Cables of rated voltages up to and including 450 / 750 V
	Polyvinyl chloride (PC) insulated flexible cords	MS 140 : 1987	MS2112-1:2009 Part 1 : General Requirements
			MS2112-2:2009 Part 2 : Test Methods
		Equiv stds :	MS2112-3:2009 Part 3 : Non-Sheathed Cables for Fixed Wiring
		BS/IEC/AS	MS2112-4:2009 Part 4 : Sheathed Cables for Fixed Wiring
		DIN/JIS/UL	MS2112-5:2009 Part 5 : Flexible Cables
			MS2112-6:2009 Part 6 : Cables for Lift and Flexible Connections
	Rubber insulated cord and flexible cables	MS 140 : 1987	Under review, to retain under MS 140 : 1987

Anatomy of Sub-Standard Cables

PHOTOGRAPH OF TEST SAMPLE

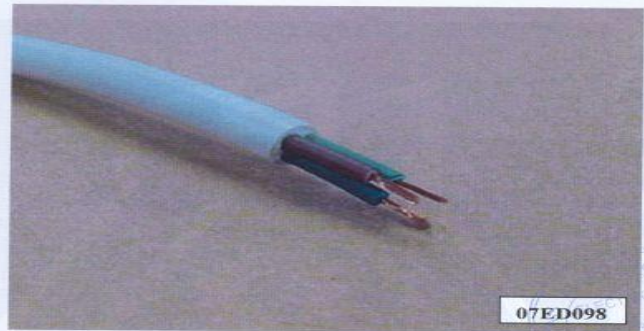

PHOTOGRAPH OF TEST SAMPLE

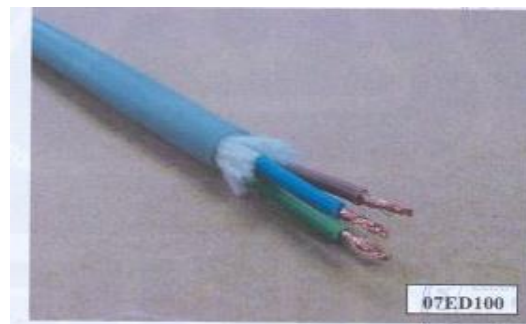
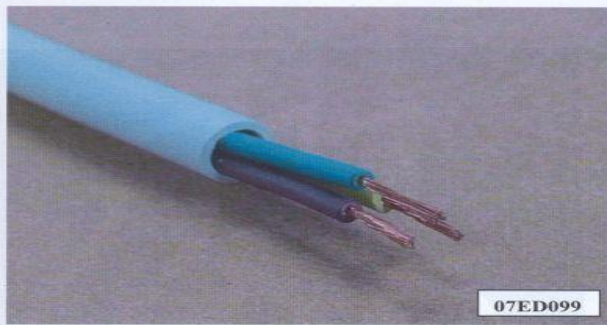

REPORT NO.: 2007ED121	PAGE : 2 OF 8
<small>This Test Report refers only to samples submitted by the applicant to SIRIM QAS International Sdn. Bhd. and tested by SIRIM QAS International Sdn. Bhd. This test report shall not be reproduced, except in full and shall not be used for advertising purposes by any means or forms without written approval from Executive Director, SIRIM QAS International Sdn. Bhd.</small>	

NOTES:

- This is a partial test report.
- All the tests were conducted at SIRIM QAS International Sdn. Bhd. And had been checked in accordance with the following clauses:
 - Clause 5.1, 6.2, 7.2, 7.3, 7.4, 19.3 and 22.3 of MS 140: 1987
 - Clause 7.1, 7.2, 7.3 and 7.4 of MS 69: 1995
 - Tensile & elongation (before ageing) and resistance to crack of MS 138: 1995
- The test sample as described in this test report deemed to comply with the requirements of those test conducted except clause 7.2 and 7.4 of MS 69: 1995 and tensile & elongation (before ageing) of MS 138: 1995.

ADDITIONAL INFORMATION:

- Tested by : Effahaikal Mahmudi Signature : [Signature] Date : 3/01/08
- Checked by : Mr.Suriani Rasol Signature : [Signature] Date : 3/1/08
- Date of test sample(s) received;
 - 1st submission : 11 October 2007
 - 2nd submission : -
 - 3rd submission : -

Prepared by:

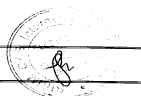

REPORT NO.: 2007ED122	PAGE : 2 OF 8
<small>This Test Report refers only to samples submitted by the applicant to SIRIM QAS International Sdn. Bhd. and tested by SIRIM QAS International Sdn. Bhd. This test report shall not be reproduced, except in full and shall not be used for advertising purposes by any means or forms without written approval from Executive Director, SIRIM QAS International Sdn. Bhd.</small>	

NOTES:

- This is a partial test report.
- All the tests were conducted at SIRIM QAS International Sdn. Bhd. And had been checked in accordance with the following clauses;
 - Clause 5.1, 6.2, 7.2, 7.3, 7.4, 19.3 and 22.3 of MS 140: 1987
 - Clause 7.1, 7.2, 7.3 and 7.4 of MS 69: 1995
 - Tensile & elongation (before ageing) and resistance to crack of MS 138: 1995
- The test sample as described in this test report deemed to comply with the requirements of those test conducted except clause 7.2 and 7.4 of MS 69: 1995 and tensile & elongation (before ageing) of MS 138: 1995.

ADDITIONAL INFORMATION:

- Tested by : Effahaikal Mahmudi Signature : [Signature] Date : 3/01/08
- Checked by : Mr.Suriani Rasol Signature : [Signature] Date : 3/01/08
- Date of test sample(s) received;
 - 1st submission : 11 October 2007
 - 2nd submission : -
 - 3rd submission : -

Prepared by:

REPORT NO.: 2007ED123	PAGE : 2 OF 7
<small>This Test Report refers only to samples submitted by the applicant to SIRIM QAS International Sdn. Bhd. and tested by SIRIM QAS International Sdn. Bhd. This test report shall not be reproduced, except in full and shall not be used for advertising purposes by any means or forms without written approval from Executive Director, SIRIM QAS International Sdn. Bhd.</small>	

NOTES:

- This is a partial test report.
- All the tests were conducted at SIRIM QAS International Sdn. Bhd. And had been checked in accordance with the following clauses;
 - Clause 5.1, 6.2, 7.2, 7.3, 7.4, 19.3 and 22.3 of MS 140: 1987
 - Clause 7.1, 7.2, 7.3 and 7.4 of MS 69: 1995
 - Tensile & elongation (before ageing) and resistance to crack of MS 138: 1995
- The test sample as described in this test report deemed to comply with the requirements of those test conducted except clause 5.1 of MS 140: 1987, clause 7.2 and 7.4 of MS 69: 1995 and tensile & elongation (before ageing) of MS 138: 1995.

ADDITIONAL INFORMATION:

- Tested by : Effahaikal Mahmudi Signature : [Signature] Date : 3/01/08
- Checked by : Mr.Suriani Rasol Signature : [Signature] Date : 3/01/08
- Date of test sample(s) received;
 - 1st submission : 11 October 2007
 - 2nd submission : -
 - 3rd submission : -

Prepared by:



Sub-Standard Cable – Electrical Properties

Item	<i>Flexible Cable 40/0.16mm (0.75sqmm) x 3C</i>				
Reference		STD	07ED100	07ED099	07ED098
Conductor					
- resistance	ohm/km	26	29.8	69.3	112
- equiv area	sqmm	0.731	0.638	0.274	0.170
Current rating	amp	7.5	6.5	2.8	1.7
Short cct rating	amp	84.0	73.3	31.5	19.5
Voltage drop	mv/A/m	63	72	168	271
Max length (2.5% drop)	metres	14	12	5	3

Sub-Standard Cables Cost Analysis

Reference		STD	07ED100	07ED099	07ED098
Cu price	Myr/kg	30	30	30	30
PVC price	Myr/kg	4.5	4.5	4.5	4.5
Cu	Myr/m	0.585	0.510	0.219	0.136
PVC	Myr/m	0.154	0.199	0.200	0.227
Material cost	Myr/m	0.739	0.709	0.419	0.363
ROS (material only)	Margin	0%	4%	76%	104%

“Sub-standard cables...

Its a lucrative business”

Sub-Standard Cables

Item	<i>Flexible Cable 40/0.16mm (0.75sqmm) x 3C 300/500V PVC/PVC</i>				
Reference		STD	07ED100	07ED099	07ED098
Conductor					
- number of wires		40	39	38	38
- resistance	ohm/km	26	29.8	69.3	112
- equiv area	sqmm	0.731	0.638	0.274	0.170
- cond diam	mm	1.061	0.991	0.650	0.511
- total weight	gm/m	19.490	17.004	7.312	4.524
Insulation					
- nominal thickness	mm	0.56	0.65	0.75	0.95
- weight per core	gm/m	4.278	5.027	4.948	6.542
- total weight	gm/m	12.834	15.080	14.843	19.625
- core diam	mm	2.181	2.291	2.150	2.411
- laidup diam	mm	4.711	4.949	4.644	5.208
Sheath					
- overall diam	mm	6.4	7.07	6.89	7.36
- nominal thickness	mm	0.84	1.06	1.12	1.08
- calc mass	litre	14.739	20.023	20.347	21.240
- total weight	gm/m	21.371	29.034	29.504	30.798
Cable overall weight	gm/m	53.7	61.1	51.7	54.9

Myths of Sub-Standard Cable Conductors

- Conductors are smaller due to “technological improvements”
- Copper purity is higher
- Able to withstand higher temperatures
- Able to take more current
- The standards have “changed”
- There is no problem, it still works

Conductor Resistance

Definition [\[edit\]](#)

Resistors or conductors with uniform cross-section [\[edit\]](#)

Many [resistors](#) and [conductors](#) have a uniform cross section with a uniform flow of electric current, and are made of one material. (See the diagram to the right.) In this case, the electrical resistivity ρ (Greek: [rho](#)) is defined as:

$$\rho = R \frac{A}{\ell},$$

where

R is the [electrical resistance](#) of a uniform specimen of the material (measured in [ohms](#), Ω)

ℓ is the [length](#) of the piece of material (measured in [metres](#), m)

A is the [cross-sectional area](#) of the specimen (measured in [square metres](#), m^2).

The reason resistivity is defined this way is that it makes resistivity an [intrinsic property](#), unlike [resistance](#). All copper wires, irrespective of their shape and size, have approximately the same [resistivity](#), but a long, thin copper wire has a much larger [resistance](#) than a thick, short copper wire. Every material has its own characteristic resistivity – for example, resistivity of rubber is far larger than copper's.

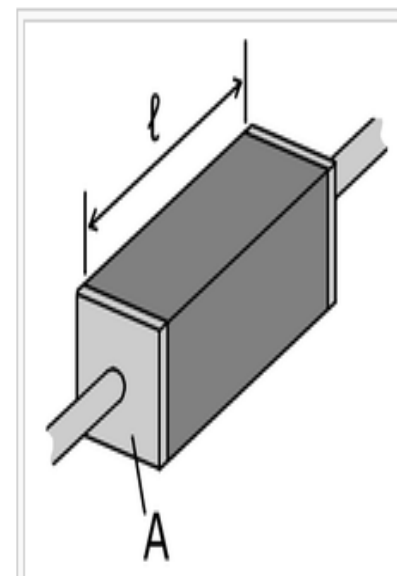

A piece of resistive material with electrical contacts on both ends. 

Conductor Constructions



Solid

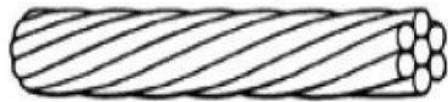

Stranded

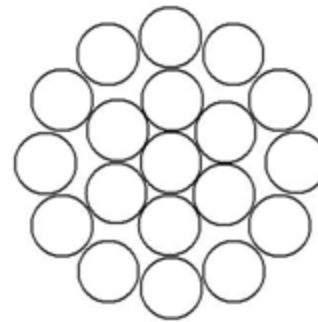

Concentric,
Non-compacted

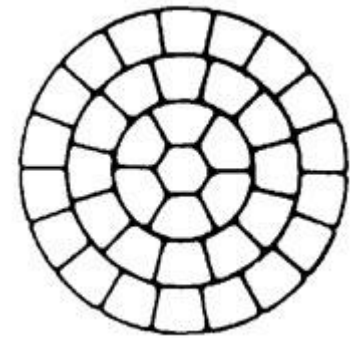

Compacted

Conductor Metals – Cost per mho/km

Metals	VR @ 20°C (Ω.mm ² /km)	Density (gm/cm ³)	Mass (kg/km)	1990 (US\$/km)	2015 (US\$/km)
Silver	16.4	10.5	172.2	29,205	116,044
Copper	17.2	8.89	152.9	255	799
Gold	24.4	19.3	470.9	3,925,590	19,789,913
Aluminium	28.3	2.7	76.4	110	112
Tin	124	7.29	904	4,742	14,122
Lead	214	11.4	2440	754	4,243

Aluminium & Copper Conductors

- **Copper**

- Highly Conductive
- Good Mechanical Properties
- Relatively Easy to Process
- Usually Annealed

- **Aluminium**

- 60% conductance of copper at same size
- Half the weight of copper at the same conductance

Detecting Sub-Standard Cables (DIY)

- Check labels and markings for size, type, manufacturer name/logo and product standard
- Verify physical measurements against manufacturers' data
- Estimate the cross-sectional area of conductor by physical measurement i.e. area x number of wires
- Conduct a conductor d.c. resistance measurement to the Standards
- **Demo During Factory Visit**

Standard Cable Marking

MS 2112-1:2009

5 Marking

5.1 Indication of origin and cable identification

Cables shall be marked with the following details:

- a) name of manufacturer;
- b) voltage designation;
- c) number and size of conductor; and
- d) standard number.

Cables for use at a conductor temperature exceeding 70 °C shall be marked with the maximum conductor temperature. Marking may be by printing or by embossing on the insulation or sheath.

5.2 Continuity of marks

The distance between the end and start of each element shall not exceed 50 mm while the distance between the end and start of each complete set of elements shall not exceed 550 mm.

5.3 Durability

Printed markings shall be durable. Compliance with this requirement shall be checked by the test given in 4.5 of MS 2112-2.

5.4 Legibility

All markings shall be legible.

Example of Std Cable Marking

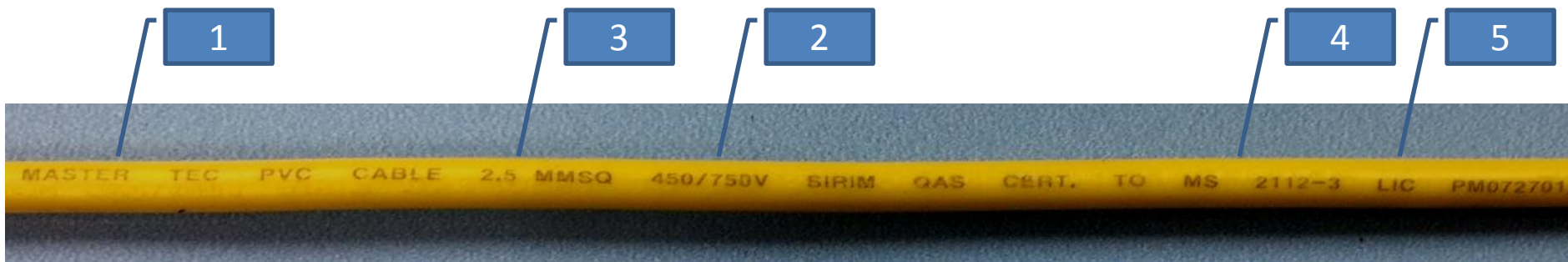

1. Manufacture Trade Mark : MASTER TEC
2. Voltage Rating 450/450V
3. Cable Size 2.5 mmsq
4. Standard : SIRIM QAS CERT TO MS 2113-3
5. Others : Sirim PLS Number : LIC PM 072701 (Optional)

Conclusion

These sub-std cables are ;

- So easily & so readily available, in various forms & sizes
- Produced at only a fraction of the cost of authentic MS standard cables
- Operable but with a short life and a high risk on safety and future mitigation cost
- Will slowly & surely cause the downfall of true MS std local cable manufacturers.

The lack of control, the existence and the use of cheap, sub-std cables are a clear continuation of our past, indicative of the practices of a 3rd world country..

Malaysia vs Sub-Standard Cables – The Way Forward

- ✓ To review & establish MS standards for cables & wires in full compliance with international standards and with due consideration given to meet pertinent local requirements, conditions & practices
- ✓ To publicize and promote the use of MS standards where available on cables and wires for domestic use, local installations and elsewhere by Malaysian contractors
- To combat against the manufacture, importation and use of sub-standard cables in the interest of public safety and towards sustaining an equitable and economically viable business for the cable manufacturing sector
- To support all measures by the relevant authorities including the imposition of clear labeling and the prohibition of retail selling of cables and wires without the MS standard mark of approval for items listed under the control of Suruhanjaya Tenaga (ST)
- ❖ To advocate the registration of all local manufacturers under MCMA as a prerequisite to be a supplier of the ST controlled MS standard cables
- ❖ To continually support and enhance the local economy and the Buy Malaysia campaign via the use of a wide range of cables in full compliance to applied standards, Made in Malaysia

“In the insurance business, an **underwriter** is a company liable for insured losses (in return for a fee/premium)”

It's what's behind the UL Mark that makes the difference..

- The UL compliance system helps ensure compliance and reduce liability and risk across the entire supply chain.
- Our Follow-up Service (FUS) program helps manufacturers gain a competitive edge based on quality, reputation and service, making it more difficult for manufacturers that produce counterfeit or inferior products to survive.
- Our longstanding history in certification and standards development makes us a trusted thought leader in the compliance arena. Stakeholders rely on UL for research, knowledge and technical solutions to address safety issues and advise on new technologies.
- Comprehensive factory and market surveillance programs help to ensure a more compliant supply chain, fair competition in the marketplace, and reduce the risk and costs associated with unsafe products while helping to protect brand reputation and the integrity of the UL Mark.
- The well proven UL anti-counterfeiting program leverages law enforcement expertise with a fully dedicated global security and brand protection operation team who work with authorities and global customs agencies combat counterfeiting.
- The use of the holographic label system sets UL apart by establishing a unique identifier for customs, regulators, buyers, retailers and consumers.
- Some product categories have the option for an additional on-demand promotional opportunity to include a direct link to your company website, product page, brochure, data sheet or flyer through UL's iQTMdatabases.
- UL offers global testing and certification solutions for acceptance in North America, Latin America, Europe, Middle East and Asian countries. UL ranked second in terms of the number of CB certificates issued worldwide.¹
- We continue to extend UL's capabilities and services to meet our customers' increasing needs. Our goal is to help our customers rapidly develop and launch safer, superior products and meet the shifting requirements of a changing world.



The *Malaysian Cable Manufacturers Association* or *MCMA* (formerly known as the *Malaysian Electrical Cable & Wire Assoc. or MECWA*), was established in 1980 comprising manufacturers of power and telecommunication cables with the following objectives:

To provide a platform of communication and enhance the cooperation of all members on matters of common interest to the industry

To promote the products & services and activities of members locally and abroad via a common website and by participation in seminars, exhibition and conferences

To represent and safeguard the interest of members through channels of discussion and liaison with customers, government agencies and other organisations

To actively participate and contribute to the development of MS Standards on Electric Cables and related products

To enhance the reputation of MCMA as an ethical and responsible association of members with a positive contribution to the community

www.mcma.org.my