

Grid Requirements For Connection and Operation of Large Scale Solar Photovoltaic (PV) Power Generation in Peninsular Malaysia

Mohd Yusof Rakob
(yusofrakob@yahoo.com)

Progress on this work so far

Work done	Date
1 st presentation at Malaysian Grid Code Committee (MGCC) meeting – <i>Introduction of Large Utility Scale Solar Photovoltaic (PV) Power Generation</i>	MGCC Meeting 25 March 2014
2 nd presentation at MGCC meeting – <i>Proposal for changes of the Malaysian Grid Code</i>	MGCC Meeting 19 Sep 2014
Workshop on Large Utility Scale Solar Photovoltaic (PV) Power Generation Connection to the Grid System – <i>Proposal for changes of the Malaysian Grid Code</i>	22 Dec 2014

General Topology of a Solar PV Power Station

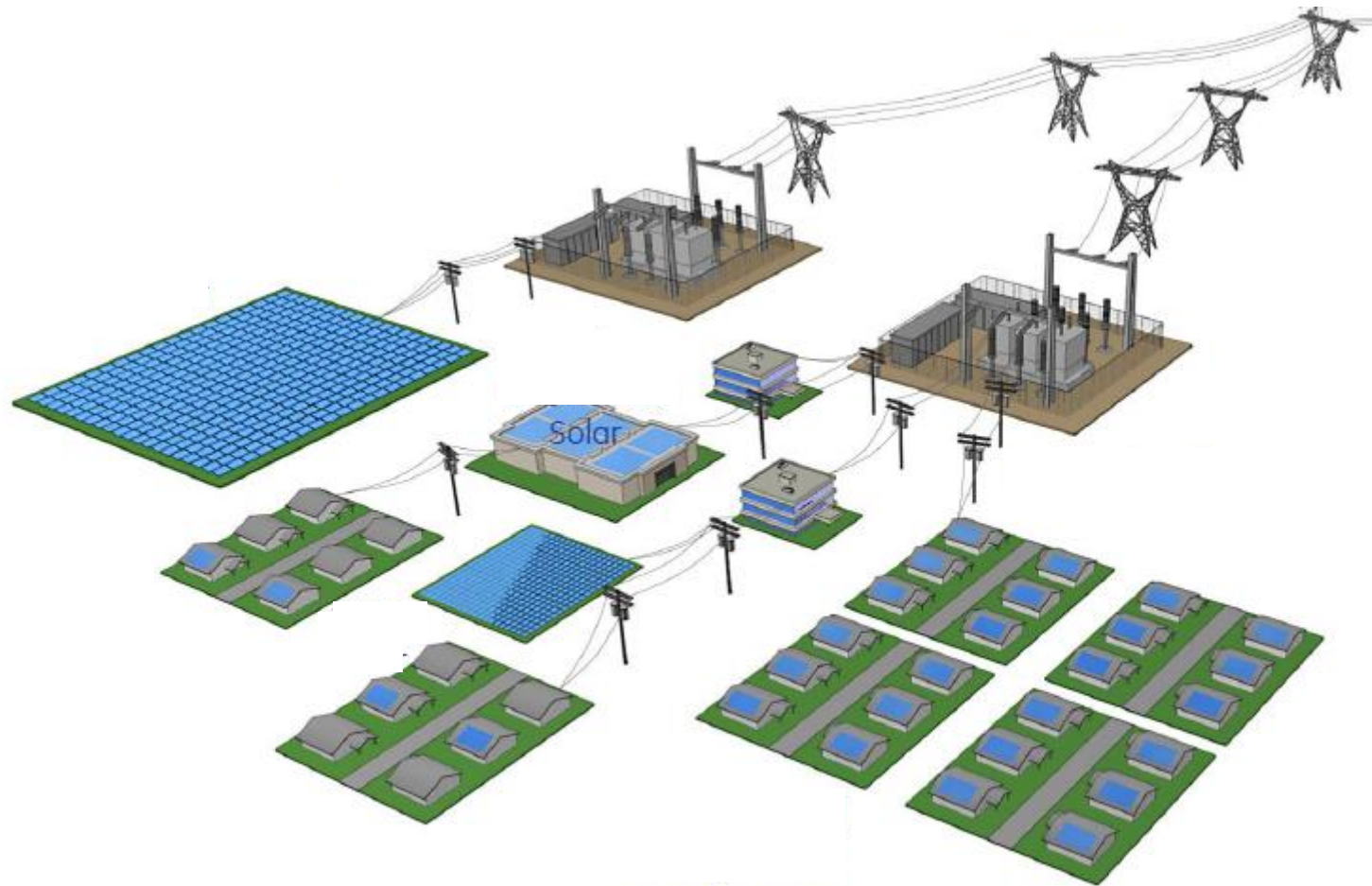

Definition of terms; Introducing Power Park Unit and Module

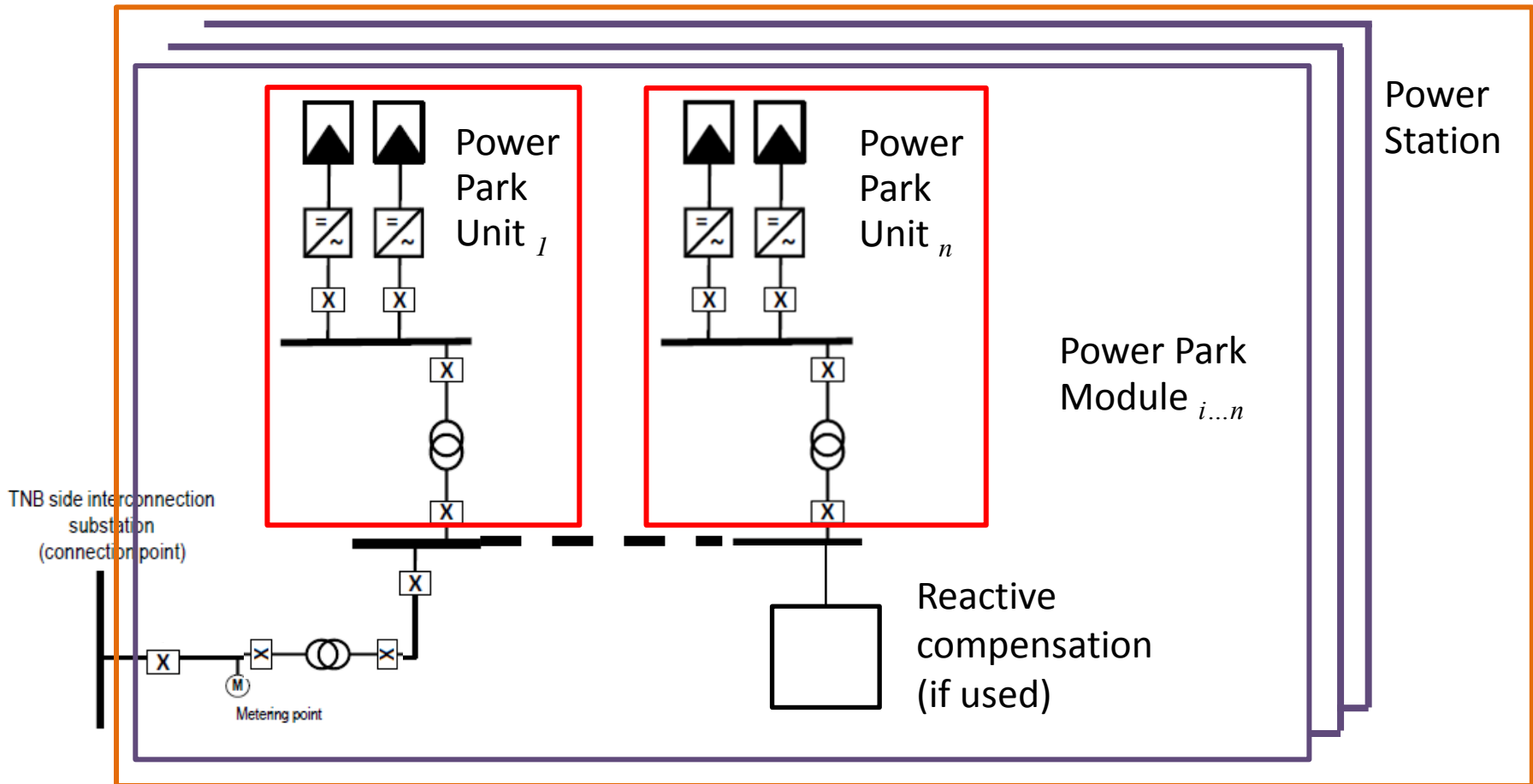

Note: *The terms of Power Park Unit and Power Park Module are not yet used in MGC. Power Park Units $1,2,\dots,n$ and Power Park Modules $1,2,\dots,n$ may or may not be identical.*

Definition of terms; Introducing Power Park Unit and Module

Terms	Definition
Generating Unit*	Unless otherwise provided in the Grid Code, any Plant and/or Apparatus which produces electricity, including, for the avoidance of doubt, a CCGT Unit.
Power Park Module*	A collection of one or more Non-Synchronous Generating Units (registered as a Power Park Module under the PC) that are powered by <u>an Intermittent Power Source</u> , joined together by a System with a single electrical point of connection directly to the Transmission System. The connection to the Transmission System may include a DC Converter.
Power Park Unit*	An individual Generating Unit within a Power Park Module.
Power Station*	An installation comprising one or more Generating Units or Power Park Modules (even where sited separately) owned and/or controlled by the same Generator, which may reasonably be considered as being managed as one Power Station.

Note: * (black font)

* (red font)

MGC Ver 1/2013 Part I: Glossary and Definitions

Terms & definitions are under consideration in this proposal

Adapting Grid Code/Standards with Intermittent Power Source

Parameters	UK (Grid Code)	USA California	India (Grid Code)	Germany (Tennet)	Australia (SA)
Submission of forecast output (declaration)	√	√	√	○	√
Active power control (set point) by GSO	√	√	√ (wind)	√ (down)	√
Active power control (ramp up) - auto	√	√	√ (wind)	√	√
Active power control (ramp down) - auto	√	√	√ (wind)	√	√
Frequency response (high freq.) - auto	√	√	○	○	√ (civil)
Frequency response (low freq.) - auto	√	√	○	√	√ (civil)
Reactive power (Q) control - auto	√	√	○	√	√
Voltage control – auto and by set point	√	√	○	√	√
Fault Ride Through capability - auto	√	√	√ (wind)	√	√
Submission of system parameters and simulation model	√	√	○	√	√

√ = YES; ○ = NO

Revision of MGC; Summary of the proposed changes

Objectives

To study the existing MGC to examine the parts which need to be modified in order to facilitate integration of large solar PV connected to the Grid System of Peninsular Malaysia, by:

1. Removing barriers and ambiguities which otherwise are against the integration
2. Insert new requirements to be complied by large solar PV Generators which are required for maintaining security and reliability of the grid system.

Revision of MGC; Summary of the proposed changes

Scope

Parts	Code	Remarks
	Preface (P)	
Part I	Glossary and Definitions (GD)	
Part II	Introduction and Purpose (IP)	
Part III	General Conditions (GC)	
Part IV	Planning Code (PC)	Including appendices PCA.1 ~ 8, App B
Part V	Connection Code (CC)	Including appendices CCA.1~4
Part VI	Operation Code (OC)	Covers OC1~11 including appendices
Part VII	Scheduling and Dispatch Code (SDC)	Covers SDC1~3 including appendices
Part VIII	Data Registration Code (DRC)	
Part IX	Metering Code (MC)	

Note: * (black font) as per MGC Ver 1/2013
 * (red font) Changes to MGC Ver 1/2013 are proposed

Main highlights of the proposed changes (additions for PV Power Generation)

Forecast output profile (Active Power) capability based on Good Industry Practice

Good Industry Practice refers to the exercise of that degree of skill, diligence, prudence and foresight which would reasonably and ordinarily be expected from a skilled and experienced operator engaged in the same type of undertaking under the same or similar circumstances.

Forecasting output profile (Active Power) based on Good Industry Practice is required to enable :

- An understanding of the possible profile of output;
- Establishing the level of energy input from the Intermittent Power Source for monitoring and Ancillary Services and will be used to provide GSO with advanced warning of solar power shutdown;
- Scheduling the operations of Generating Units which shows the combination of Power Park Units running in relation to any given MW output.

Main highlights of the proposed changes (additions for PV Power Generation)

Reactive Power at the Connection Point

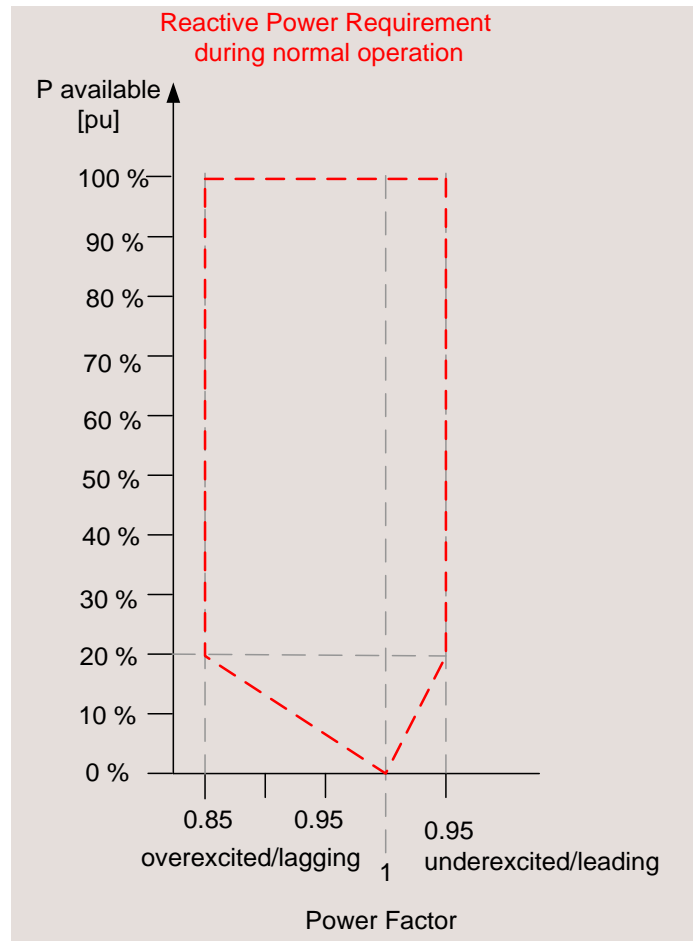

Main highlights of the proposed changes (additions for PV Power Generation)

Active Power output frequency response capability at the Connection Point

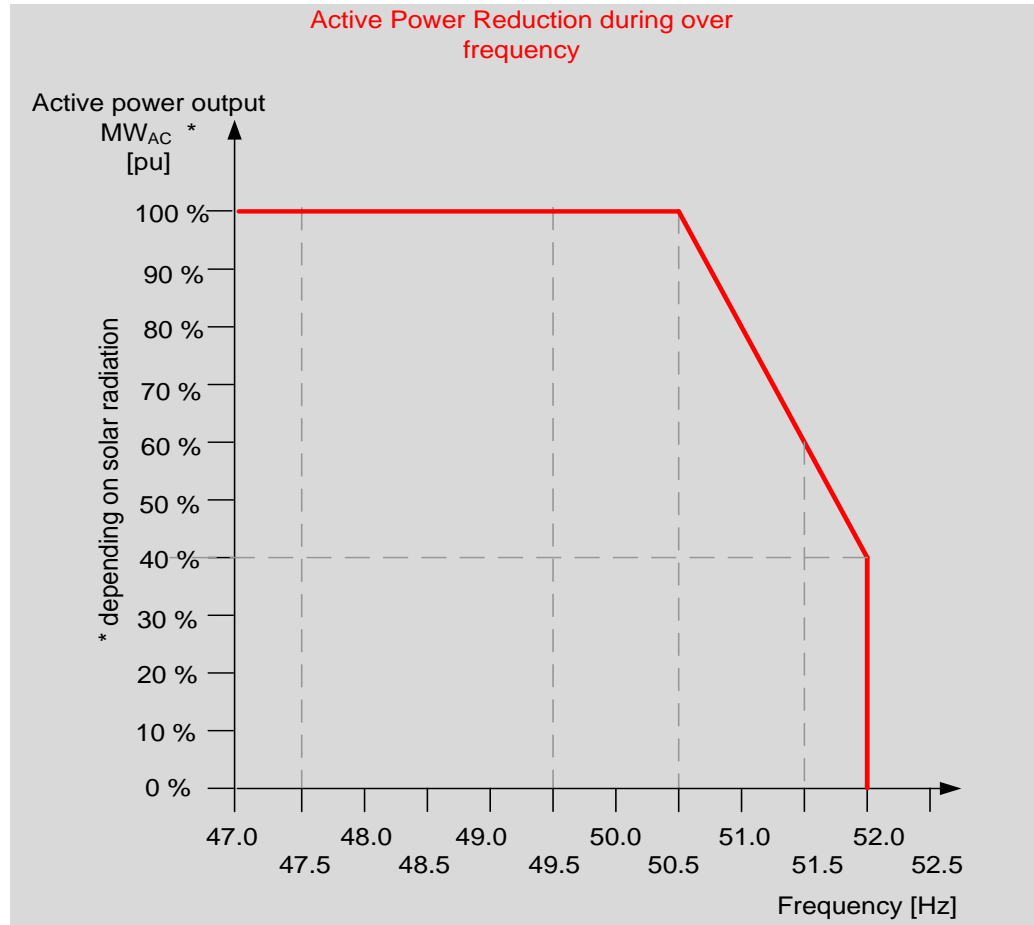

Main highlights of the proposed changes (additions for PV Power Generation)

Frequency control device equivalent droop between 3% and 5%

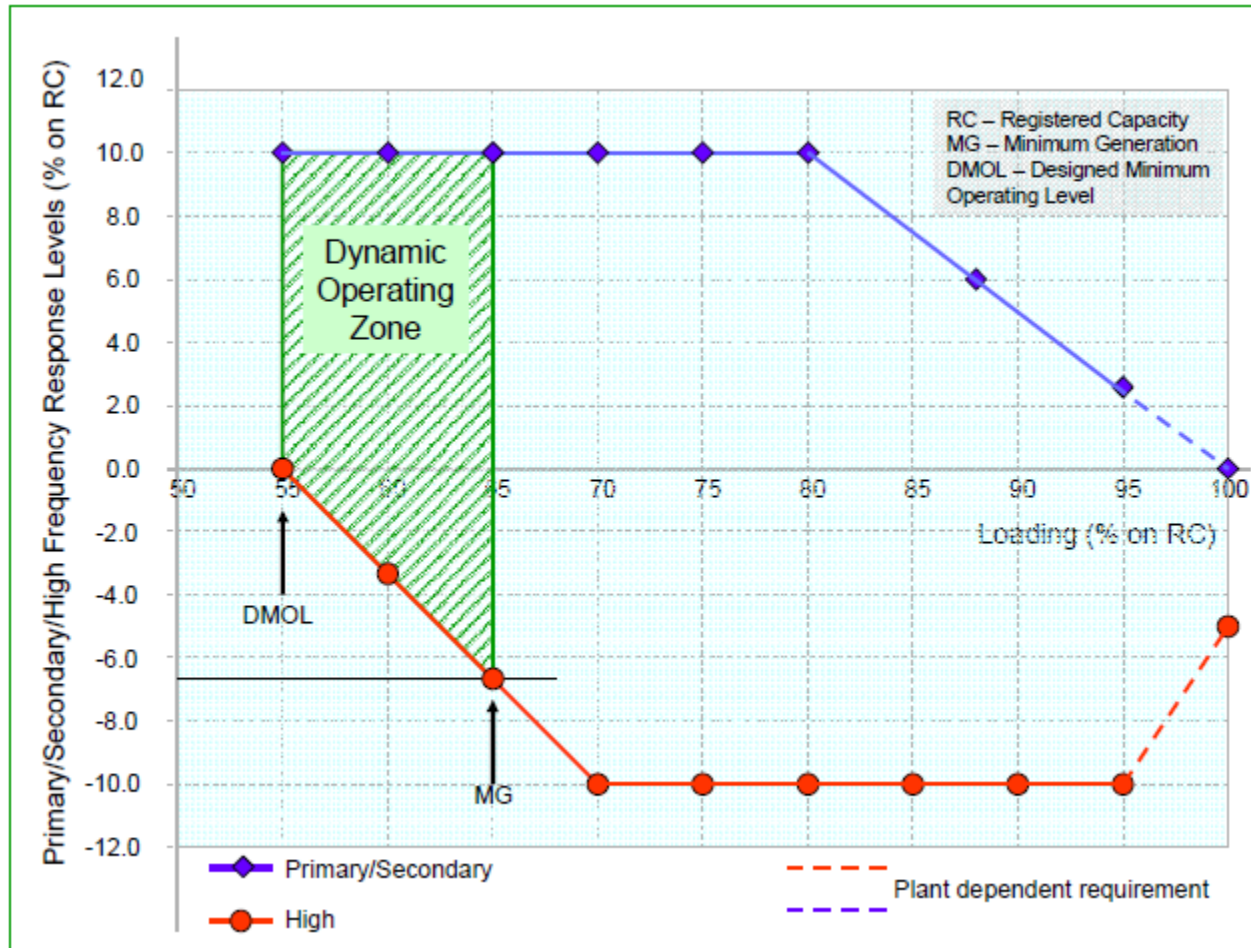

Main highlights of the proposed changes (additions for PV Power Generation)

Reactive Power output under steady state conditions

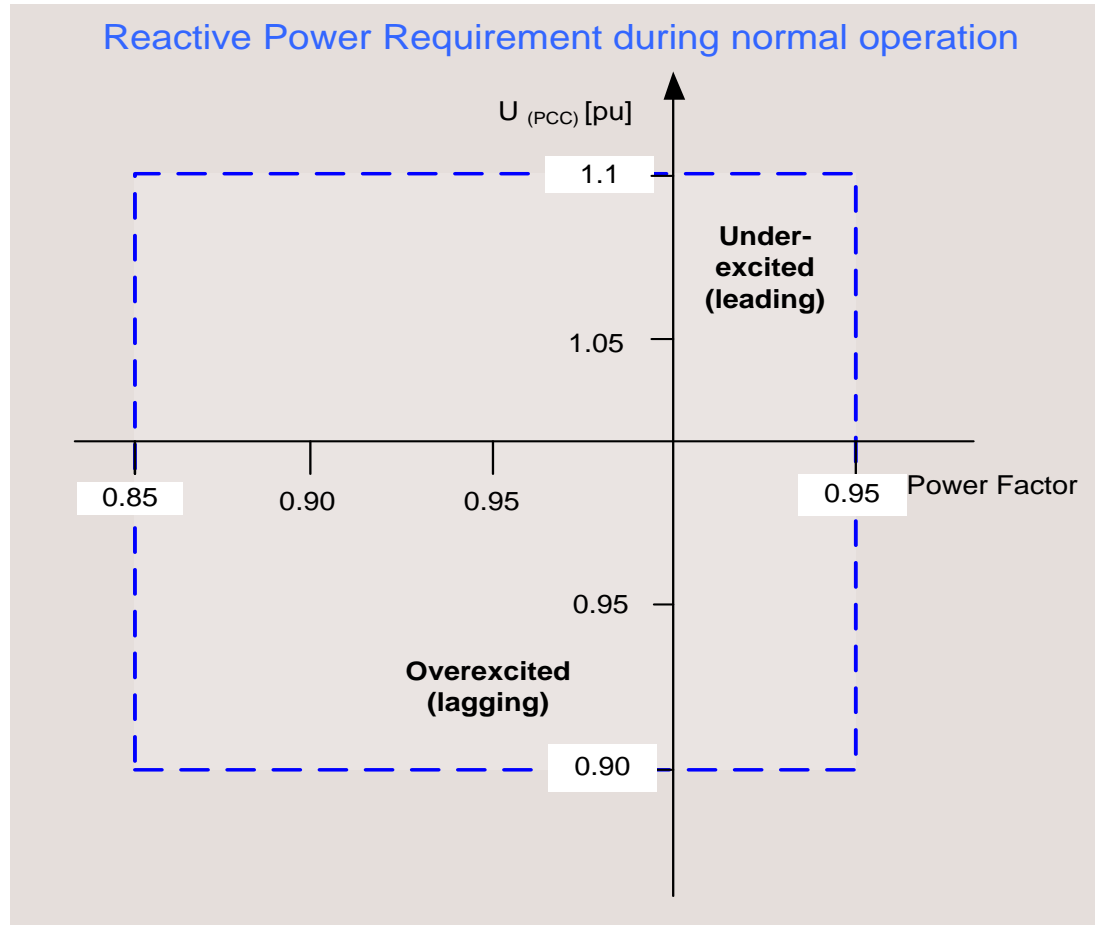

Main highlights of the proposed changes (additions for PV Power Generation)

Fault Ride Through Capability

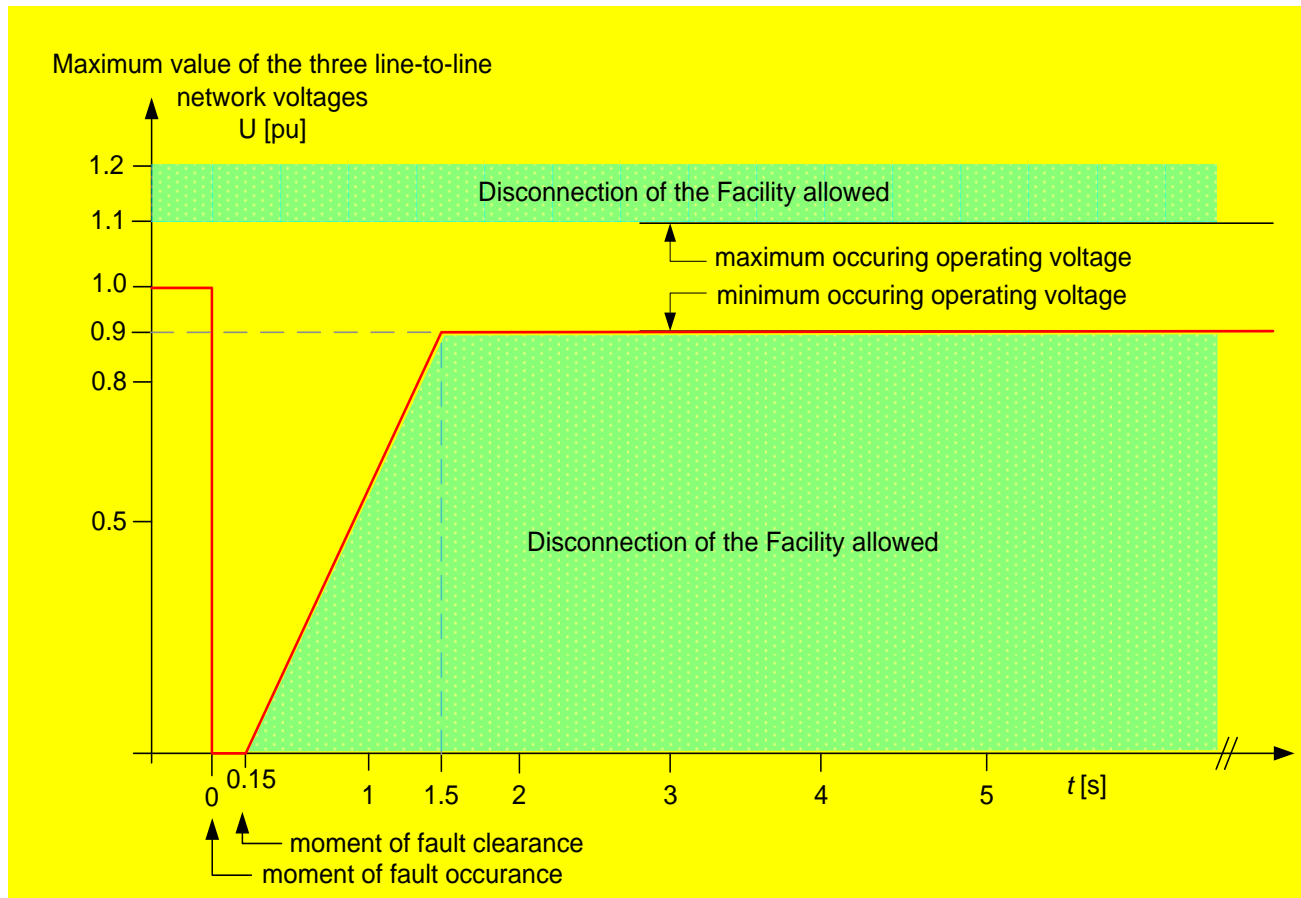

Main highlights of the proposed changes (additions for PV Power Generation)

Submission of system parameters and simulation model

Transfer function block diagram representation including parameters of AC filter and reactive compensation equipment control systems, including any time delays, encompassing the following control functions:

- Frequency and/or load control systems;
- small signal modulation controls such as power oscillation damping controls or sub-synchronous oscillation damping controls, if installed;
- Reactive Power control at converter ends for a voltage source converter

Details of the systems described in transfer function block diagram shall show transfer functions of individual elements and in a form that is compatible with the software specified by Grid Owner.

Grid Requirements For Connection and Operation of Large Scale Solar Photovoltaic (PV) Power Generation in Peninsular Malaysia

End of Presentation

Grid Requirements For Connection and Operation of Large Scale Solar Photovoltaic (PV) Power Generation in Peninsular Malaysia

Q&A